



Quality of Light

Distributed by **SYSTEMATIC VISION**
bill@systematicvision.com
508-532-1116



MACHINE VISION LENSES

Kowa Optronics Co., Ltd.

4th Fl., Toko Bldg. 11-1 Nihonbashi-honcho 4-chome, Chuo-ku, Tokyo 103-0023, Japan
Phone: +81(3)5651-7061 Facsimile: +81(3)5651-7310
E-mail: opt-cctv@kowa.co.jp URL: <http://www.kowa-optical.co.jp/fa/e/>

Kowa American Corporation

20001 South Vermont Avenue, Torrance, CA 90502, U.S.A.
Phone: +1(310)327-1913 Facsimile: +1(310)327-4177
E-mail: customerservice@kowa.com URL: <http://www.kowa-usa.com>

Kowa Optimed Deutschland GmbH

Fichtenstrasse 123, 40233 Düsseldorf, Germany
Phone: +49 (0)211-542184-00 Facsimile: +49 (0)211-542184-10
E-mail: lens@kowaoptimed.com URL: <https://www.kowaoptimed.com/>

Kowa-Emori (Thailand) Co., Ltd.

90/28, 11th Floor, Sathorn Thani Building 1,
North Sathorn Road, Silom, Bangrak, Bangkok, 10500 Thailand
Phone: +66-2-238-2606-07
E-mail: opt-cctv@kowa.co.jp URL: <https://www.emori.co.jp/en>

Kowa Asia Pacific Pte. Ltd.

16 Collyer Quay #16-00, Income At Raffles, Singapore 049318
Phone: +65 6222-0025 Facsimile: +65 6422-4589
E-mail: david@kowa.com.sg

Kowa India Pvt. Ltd.

Ahmedabad Branch

302/3rd Floor, A-wing, Shikher Complex, Near Adani House, Mithakali Cross Road,
Navrangpura, Ahmedabad - 380009 Gujarat India
Phone: +91(79)2644-7181
E-mail: lens@kowaindia.com URL: <http://www.kowalenses.in>





About Us

Kowa Optronics Co., Ltd. is part of Kowa Company, Ltd., one of the largest privately owned companies in Japan. Founded in 1894, Kowa produces a wide variety of products in a number of industries, including but not limited to healthcare, industrial, and energy conservation sectors.

Since 1946, Kowa has developed and manufactured high-end optical equipment such as CCTV and machine vision lenses, spotting scopes, handheld binoculars, and coin operated binoculars.

With over 70 years of technical experience, Kowa Optronics Co., Ltd. continues its tradition of being a leader in its industries by providing innovative solutions and new technologies to solve even the toughest vision system obstacles.



Function Icons

- LOAT** Floating Mechanism Design
- XD** Extra Low Dispersion
- LO-DIS** Low Distortion
- RUGGED** Ruggedized lens
- WR** Water Resistance
- DR** Dust Resistance
- WBMC** Wide-Band Multi-Coating
- SWIR** SWIR Coating
- IR** IR-Corrected
- 3CMOS** 3CMOS Camera

2" 50MEGAPIXEL 3.1 μ m

VM Series NEW

- ▶ Large image size of ϕ 32mm with M42-mount or TFL-mount.
- ▶ High quality lenses with a resolving power of 3.1 μ m.
- ▶ Suitable for 8K resolution and are rated at up to 50 megapixels for use with top performance cameras.



1.1" 24 MEGAPIXEL 2.5 μ m

FC24M Series NEW

- ▶ 2.5 μ m pixel pitch high resolution compact lens.
- ▶ High traceability by QR code management.
- ▶ Compatible with maximum 1.2inch format size.



1" 12 MEGAPIXEL IR-CORRECTED (VIS-SWIR) 3.1 μ m

HC-VIS-SW Series NEW

- ▶ A maximum of 12 megapixel and 3.1 μ m performance can be found at select wavelength ranges.
- ▶ Virtually zero focus shift from visible to 2000nm wavelength range.



	NEW 2" 50MEGAPIXEL 3.1µm VM SERIES _____ 06
	<small>LM18VM42/LM18VM35 LM25VM42/LM25VM35 LM35VM42/LM35VM35</small>
	4/3" 20 MEGAPIXEL PLUS XC SERIES _____ 08
	<small>LM8XC LM12XC LM16XC LM25XC LM35XC LM50XC</small>
	NEW 1.1" 24 MEGAPIXEL 2.5µm FC24M SERIES _____ 10
	<small>LM8FC24M LM8FC24M LM16FC24M LM25FC24M LM35FC24M</small>
	1" MEGAPIXEL PLUS HC SERIES _____ 12
	<small>LM8HC LM8HC LM12HC LM16HC LM25HC LM35HC LM50HC LM75HC</small>
	1" RUGGEDIZED MEGAPIXEL PLUS HC-V SERIES _____ 14
	<small>LM8HC-V LM12HC-V LM16HC-V LM25HC-V LM35HC-V LM50HC-V</small>
	2/3" 10 MEGAPIXEL JC10M SERIES _____ 16
	<small>LM5JC10M LM8JC10M LM12JC10M LM16JC10M LM25JC10M LM35JC10M LM50JC10M</small>
	2/3" 5 MEGAPIXEL 3.45µm JC5M2 SERIES _____ 18
	<small>LM12JC5M2 LM16JC5M2 LM25JC5M2 LM35JC5M2</small>
	2/3" ULTRA COMPACT 5 MEGAPIXEL 3.45µm JC5MC SERIES _____ 20
	<small>LM8JC5MC LM12JC5MC LM16JC5MC LM25JC5MC</small>
	WIDE MEGAPIXEL NCM/JCM SERIES _____ 23
	<small>LM3NCM LM6NCM LM5JCM</small>
	2/3" MEGAPIXEL JC1MS SERIES _____ 24
	<small>LM5JCM LM8JC1MS LM12JC1MS LM16JC1MS LM25JC1MS LM35JC1MS LM50JC1MS LM75JC1MS LM100JC1MS</small>
	2/3" RUGGEDIZED MEGAPIXEL JCM-V SERIES _____ 26
	<small>LM5JCM-V LM8JCM-V LM12JCM-V LM16JCM-V LM25JCM-V LM35JCM-V LM50JCM-V</small>
	2/3" RUGGEDIZED WATER AND DUST RESISTANCE MEGAPIXEL JCM-WP SERIES _____ 28
	<small>LM5JCM-WP LM8JCM-WP LM12JCM-WP LM16JCM-WP LM25JCM-WP LM35JCM-WP LM50JCM-WP</small>
	2/3" STANDARD JC SERIES _____ 30
	<small>LM6JC LM8JC LM12JC LM16JC LM25JC LM35JC LM50JC</small>
	1/1.8" STANDARD NCL SERIES _____ 31
	<small>LM4NCL LM5NCL LM6NCL LM12NCL</small>

	NEW 1" 12 MEGAPIXEL IR-CORRECTED (VIS-SWIR) 3.1µm HC-VIS-SW SERIES _____ 33
	<small>LM12HC-VIS-SW LM25HC-VIS-SW LM50HC-VIS-SW</small>
	2/3" 5 MEGAPIXEL IR-CORRECTED (VIS-NIR) 3.45µm JC5M-IR SERIES _____ 34
	<small>LM16JC5M-IR LM25JC5M-IR LM35JC5M-IR</small>
	1" SWIR MEGAPIXEL HC-SW SERIES _____ 35
	<small>LM8HC-SW LM12HC-SW LM16HC-SW LM25HC-SW LM35HC-SW LM50HC-SW</small>
	LINE SCAN LF SERIES _____ 36
	<small>LM28LF LM35LF LM50LF</small>
	3CCD LARGE FORMAT CLS SERIES _____ 36
	<small>LM28CLS LM35CLS LM50CLS</small>
	1/2.5" MEGAPIXEL S-MOUNT LENS _____ 37
	<small>LM3QS28 LM3QS40 LM3QS56</small>
	1/3" NF-MOUNT NF SERIES _____ 37
	<small>LM3NF LM5NF LM6NF</small>
	TELECENTRIC TC SERIES _____ 38
	<small>LM1119TC LM1138TC LM1120TC LM1121TC LM1122TC LM1123TC LM1125TC</small>
	VARIFOVAL / MACRO ZOOM _____ 40 / 41
	<small>LMV24411 LMV2990-IR LMZ45T3 LMZ69M</small>
	ACCESSORIES _____ 42

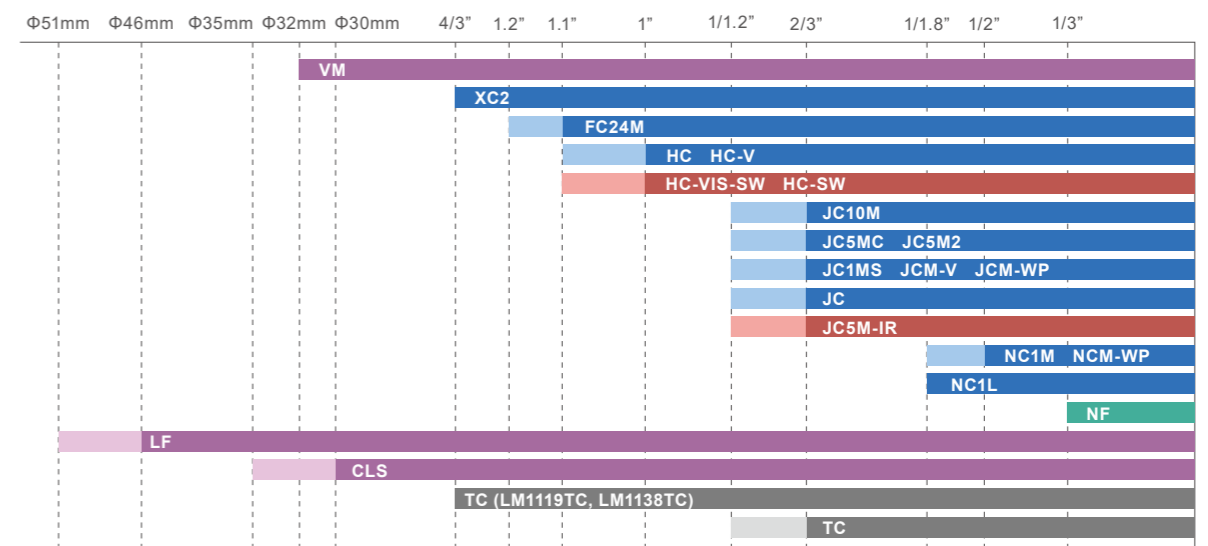

VM Series NEW

✓ Compatible ◇ Suitable — Incompatible

Model	Format Size(φ)							
	38.0	35.0	32.0	30.0	APS-C	4/3"	1.2"	1.1"
LM18VM42	—	—	✓	✓	✓	✓	✓	✓
LM18VM35	—	—	✓	✓	✓	✓	✓	✓
LM25VM42	◇	◇	✓	✓	✓	✓	✓	✓
LM25VM35	◇	◇	✓	✓	✓	✓	✓	✓
LM35VM42	◇	◇	✓	✓	✓	✓	✓	✓
LM35VM35	◇	◇	✓	✓	✓	✓	✓	✓

Features of VM Series

- ▶ Large image size of φ32mm with M42-mount or TFL-mount.
- ▶ High quality lenses with a resolving power of 3.1μm.
- ▶ Suitable for 8K resolution and are rated at up to 50 megapixels for use with top performance cameras.
- ▶ Kowa's new and innovative switch locking screw mechanism prevents thumb screws from falling off.
- ▶ The flange back distance can be modified by attaching optional mount adapters to convert to TFL-II or other formats.
- ▶ High magnification design with a focusing range as close as 0.1m away.



Optional Mount Adapters

The flange back can change by using optional mount adapters included with each lens.

Standard : M42-mount has a 17.526mm flange back distance.



Series	Mount Adapter	Flange Back (mm)	Mount
VM42	FB-1600VM	16	M42 Mount
	FB-1148VM	11.48	M42 Mount
	FB-1000VM	10	M42 Mount
	FB-0656VM	6.56	M42 Mount
	FB-1750VM	17.5	TFL-II Mount

*Mount adapters do not work with VM35 series lenses.

High Resolution Image at the Corners (LM25VM).

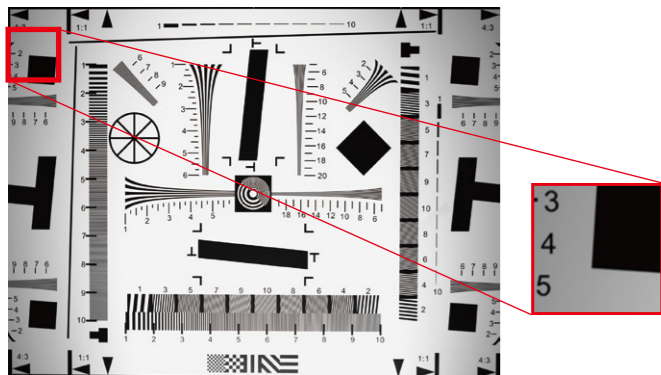

Switch Locking Screw Mechanism Prevents Fatigue Failure of Thumb Screws

Kowa's VM series features a newly designed switch locking screw mechanism that prevents thumb screws from falling off by utilizing a fixing screw that does not rotate in a set position. The thumb screw locks into place by sliding the fixing screw to the right side. It can then be detached by sliding the fixing screw to the left side.



The thumb screw can detach by sliding the fixing screw to the left side.

Applications

- Line Scan
- FPD Inspection
- Aerial photography
- Drones

† Images may differ from the actual product.

LM18VM42 NEW LM18VM35

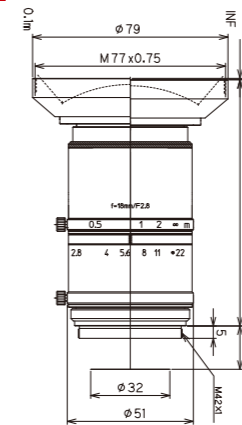

LO-DIS **FLOAT** **XD** **WBMC**
Low Distortion Floating Extra Low Dispersion Wide-Band Multi-Coating

LM25VM42 NEW LM25VM35

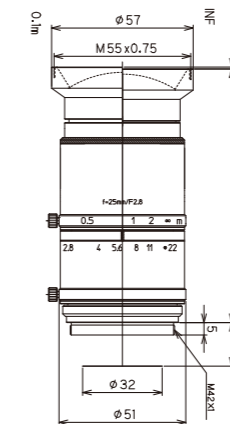

LO-DIS **FLOAT** **XD** **WBMC**
Low Distortion Floating Extra Low Dispersion Wide-Band Multi-Coating

LM35VM42 NEW LM35VM35

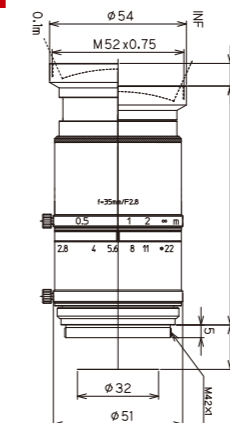

LO-DIS **FLOAT** **XD** **WBMC**
Low Distortion Floating Extra Low Dispersion Wide-Band Multi-Coating

Model	LM18VM42	LM18VM35
Focal Length(mm)	18	
Image Size(mm)	φ32	
Iris Range(F-stop)	F2.8-F16	
Focusing Range(m)	0.1~∞	
Control	Manual	
Focus	Manual	
Shooting Range at M.O.D.(mm)	172(H)×128(V)	
Angle of View	2 Inch	70.5×56.1
(Degrees)	APS-C Inch	63.4×49.7
	4/3 Inch	54.1×41.8
Resolution(Center, Corner)	160lp/mm,100lp/mm	
TV Distortion(%)	1.25	
Back Focus in Air(mm)	15.5	
Flange Focus in Air(mm)	17.526	
Mount	M42-mount	TFL-mount
Filter Thread(mm)	M77×P0.75	
Size(mm)(∞)	φ79×99.6	
Weight(g)	460	
Temperature Range	-10°C~+50°C	

Model	LM25VM42	LM25VM35
Focal Length(mm)	25	
Image Size(mm)	φ32	
Iris Range(F-stop)	F2.8-F16	
Focusing Range(m)	0.1~∞	
Control	Manual	
Focus	Manual	
Shooting Range at M.O.D.(mm)	125(H)×93(V)	
Angle of View	2 Inch	54.0×42.0
(Degrees)	APS-C Inch	48.0×37.0
	4/3 Inch	40.4×30.9
Resolution(Center, Corner)	160lp/mm,100lp/mm	
TV Distortion(%)	0.59	
Back Focus in Air(mm)	20.3	
Flange Focus in Air(mm)	17.526	
Mount	M42-mount	TFL-mount
Filter Thread(mm)	M55×P0.75	
Size(mm)(∞)	φ57×102.1	
Weight(g)	400	
Temperature Range	-10°C~+50°C	

Model	LM35VM42	LM35VM35
Focal Length(mm)	35	
Image Size(mm)	φ32	
Iris Range(F-stop)	F2.8-F16	
Focusing Range(m)	0.1~∞	
Control	Manual	
Focus	Manual	
Shooting Range at M.O.D.(mm)	76(H)×57(V)	
Angle of View	2 Inch	40.2×30.7
(Degrees)	APS-C Inch	35.4×26.9
	4/3 Inch	29.5×22.3
Resolution(Center, Corner)	160lp/mm,100lp/mm	
TV Distortion(%)	0.12	
Back Focus in Air(mm)	19.5	
Flange Focus in Air(mm)	17.526	
Mount	M42-mount	TFL-mount
Filter Thread(mm)	M52×P0.75	
Size(mm)(∞)	φ54×94.3	
Weight(g)	375	
Temperature Range	-10°C~+50°C	

† Images may differ from the actual product.

XC Series

High Resolution FA/MV Lenses

Features of XC Series

- ▶ Large image size of Φ23mm incorporated within a C-mount design.
- ▶ Megapixel resolution is maintained throughout the entire image even when the iris is fully opened.
- ▶ High precision aspherical lens greatly reduces distortion and produces a high-definition picture.
- ▶ The LM8XC generates a very wide 93.5° horizontal angle of view.
- ▶ Kowa's floating mechanism system virtually eliminates optical aberrations from close distance to infinity.

✓ Compatible ◇ Suitable — Incompatible

Model	Format Size(Inch)						
	4/3	1.2	1.1	1	1/1.2	2/3	1/1.8
LM8XC	✓	✓	✓	✓	✓	✓	✓
LM12XC	✓	✓	✓	✓	✓	✓	✓
LM16XC	✓	✓	✓	✓	✓	✓	✓
LM25XC	✓	✓	✓	✓	✓	✓	✓
LM35XC	✓	✓	✓	✓	✓	✓	✓
LM50XC	✓	✓	✓	✓	✓	✓	✓



LM16XC



LO-DIS **FLOAT** **XD** **WBMC**
Low Distortion Floating Extra Low Dispersion Wide-Band Multi-Coating

LM25XC

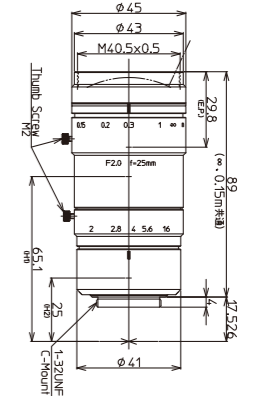

LO-DIS **FLOAT** **XD** **WBMC**
Low Distortion Floating Extra Low Dispersion Wide-Band Multi-Coating

LM35XC

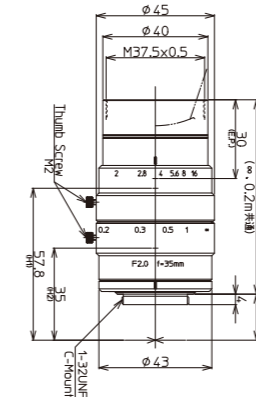

LO-DIS **FLOAT** **WBMC**
Low Distortion Floating Wide-Band Multi-Coating

LM50XC

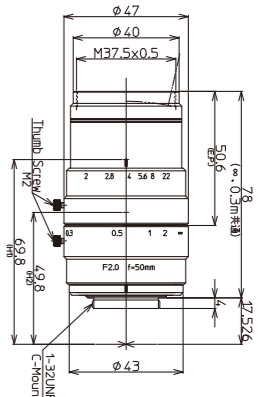

LO-DIS **FLOAT** **WBMC**
Low Distortion Floating Wide-Band Multi-Coating

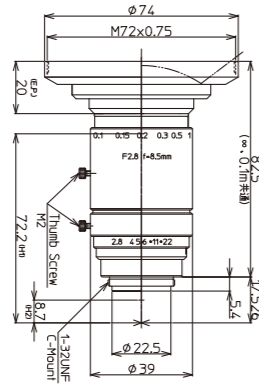

LO-DIS **FLOAT** **XD** **WBMC**
Low Distortion Floating Extra Low Dispersion Wide-Band Multi-Coating

Model	LM8XC
Focal Length(mm)	8.5
Image Size(mm)	18.4×13.8(Φ23)
Iris Range(F-stop)	F2.8~F22
Focusing Range(m)	0.1~∞
Control	Iris: Manual Focus: Manual
Shooting Range at M.O.D.(mm)	238.4(H)×179.1(V)
Angle of View (Degrees)	4/3 Inch: 93.5×77.1 1.1 Inch: 78.2×62.7 1 Inch: 72.9×57.9 2/3 Inch: 53.8×41.6
Resolution(Center, Corner)	160lp/mm, 80lp/mm
TV Distortion(%)	0.12
Back Focus in Air(mm)	12.9
Mount	C-mount
Filter Thread(mm)	M72×P0.75
Size(mm)(∞)	Φ74×82.5
Weight(g)	245
Temperature Range	-10°C~+50°C

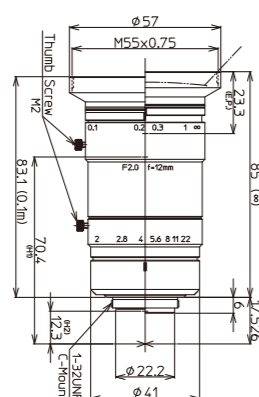

LO-DIS **FLOAT** **XD** **WBMC**
Low Distortion Floating Extra Low Dispersion Wide-Band Multi-Coating

Model	LM12XC
Focal Length(mm)	12
Image Size(mm)	18.4×13.8(Φ23)
Iris Range(F-stop)	F2.0~F22
Focusing Range(m)	0.1~∞
Control	Iris: Manual Focus: Manual
Shooting Range at M.O.D.(mm)	181.5(H)×135.5(V)
Angle of View (Degrees)	4/3 Inch: 74.9×59.6 1.1 Inch: 60.6×47.1 1 Inch: 55.9×43.1 2/3 Inch: 39.8×30.2
Resolution(Center, Corner)	160lp/mm, 80lp/mm
TV Distortion(%)	0.59
Back Focus in Air(mm)	13.0
Mount	C-mount
Filter Thread(mm)	M55×P0.75
Size(mm)(∞)	Φ57×85
Weight(g)	270
Temperature Range	-10°C~+50°C

Model	LM16XC	LM25XC	LM35XC	LM50XC
Focal Length(mm)	16	25	35	50
Image Size(mm)	18.4×13.8(Φ23)	18.4×13.8(Φ23)	18.4×13.8(Φ23)	18.4×13.8(Φ23)
Iris Range(F-stop)	F2.0~F22	F2.0~F16	F2.0~F16	F2.0~F22
Focusing Range(m)	0.1~∞	0.15~∞	0.2~∞	0.3~∞
Control	Iris: Manual Focus: Manual	Iris: Manual Focus: Manual	Iris: Manual Focus: Manual	Iris: Manual Focus: Manual
Shooting Range at M.O.D.(mm)	134.6(H)×100.8(V)	124.8(H)×93.0(V)	100.3(H)×75.3(V)	100.2(H)×75.5(V)
Angle of View (Degrees)	4/3 Inch: 60.6×47.2 1.1 Inch: 48.0×36.8 1 Inch: 44.0×33.6 2/3 Inch: 30.9×23.3	40.9×31.1 31.8×24.0 28.9×21.8 20.1×15.2	29.6×22.4 22.8×17.2 20.8×15.6 14.3×10.8	20.6×15.7 16.0×12.0 14.6×11.0 10.1×7.6
Resolution(Center, Corner)	160lp/mm, 80lp/mm	160lp/mm, 80lp/mm	160lp/mm, 80lp/mm	160lp/mm, 80lp/mm
TV Distortion(%)	0.02	-0.57	-0.17	0.80
Back Focus in Air(mm)	13.0	24.3	15.2	21.6
Mount	C-mount	C-mount	C-mount	C-mount
Filter Thread(mm)	M40.5×P0.5	M40.5×P0.5	M37.5×P0.5	M37.5×P0.5
Size(mm)(∞)	Φ45×79.5	Φ45×89	Φ45×74	Φ47×78
Weight(g)	250	255	210	235
Temperature Range	-10°C~+50°C	-10°C~+50°C	-10°C~+50°C	-10°C~+50°C

Magnification Using A Close Up Ring

You can use close up rings to increase the magnification and decrease the minimum object distance (M.O.D.) of the lens. Simply screw in the spacer ring between the threads of the lens mount and camera.



† Images may differ from the actual product.

Diagram of M.O.D. / Magnification Using A Close Up Ring

Model	LM8XC	LM12XC	LM16XC	LM25XC	LM35XC	LM50XC
(Non)M.O.D./Magnification	100mm/0.08×	100mm/0.10×	100mm/0.14×	150mm/0.15×	200mm/0.18×	300mm/0.18×
(1mm Ring)M.O.D./Magnification	30mm/0.19×	48mm/0.19×	64mm/0.20×	115mm/0.19×	174mm/0.21×	273mm/0.20×
(5mm Ring)M.O.D./Magnification	-	-	21mm/0.46×	56mm/0.35×	117mm/0.33×	204mm/0.28×
(10mm Ring)M.O.D./Magnification	-	-	-	31mm/0.55×	85mm/0.48×	158mm/0.39×
(20mm Ring)M.O.D./Magnification	-	-	-	12mm/0.96×	58mm/0.77×	115mm/0.59×

† Images may differ from the actual product.

FC24M Series NEW

High Resolution FA/MV Lens

Features of FC24M Series

- ▶ 2.5 μ m pixel pitch high resolution compact lens.
- ▶ Compatible with maximum 1.2inch format size.
- ▶ Excellent corner brightness and low distortion.
- ▶ Kowa's floating mechanism system virtually eliminates optical aberrations from close distance to infinity.
- ▶ Kowa's wide-band multi-coating effectively decreases ghost and flare and produces a high transmission from the visible to NIR wavelength range.
- ▶ High traceability by QR code management.

✓ Compatible ◊ Suitable — Incompatible

Model	Format Size(Inch)								
	4/3	1.2	1.1	1	1/1.2	2/3	1/1.8	1/2	1/3
LM6FC24M	—	—	✓	✓	✓	✓	✓	✓	✓
LM8FC24M	—	—	✓	✓	✓	✓	✓	✓	✓
LM12FC24M	—	◊	✓	✓	✓	✓	✓	✓	✓
LM16FC24M	—	◊	✓	✓	✓	✓	✓	✓	✓
LM25FC24M	—	◊	✓	✓	✓	✓	✓	✓	✓
LM35FC24M	—	◊	✓	✓	✓	✓	✓	✓	✓
LM50FC24M	—	◊	✓	✓	✓	✓	✓	✓	✓



LM6FC24M NEW

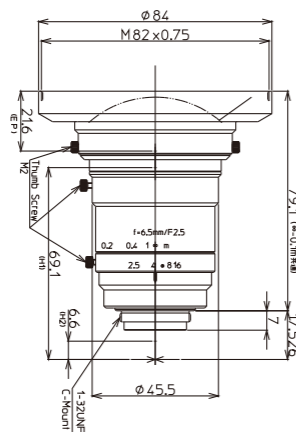

Model	LM6FC24M
Focal Length(mm)	6.5
Image Size(mm)	14.1×10.6(Φ17.6)
Iris Range(F-stop)	F2.5~F16
Focusing Range(m)	0.1~∞
Control Iris	Manual
Focus	Manual
Shooting Range at M.O.D.(mm)	256(H)×190(V)
Angle of View	1.1 Inch 95.7×78.7 1 Inch 89.9×73.0 2/3 Inch 68.1×53.5
Resolution(Center, Corner)	200lp/mm, 100lp/mm
TV Distortion(%)	-1.51
Back Focus in Air(mm)	10.9
Mount	C-mount
Filter Thread(mm)	M82×P0.75
Size(mm)(∞)	Φ84×79.1
Weight(g)	300
Temperature Range	-10°C~+50°C



LM8FC24M NEW

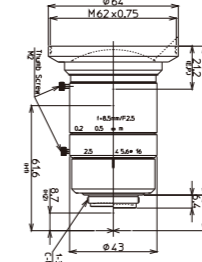

LM12FC24M NEW

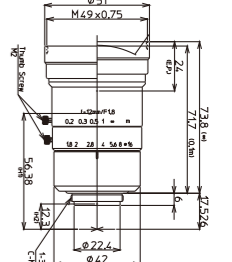

LM16FC24M NEW

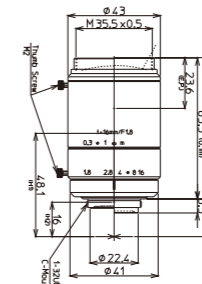

LM25FC24M NEW

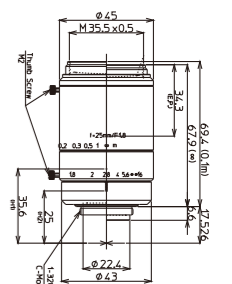

LM35FC24M NEW

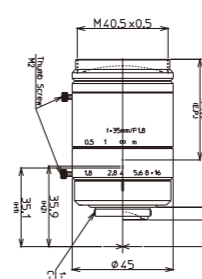

LM50FC24M NEW

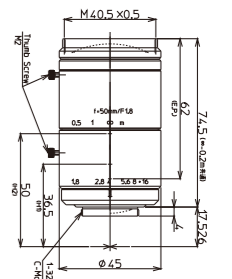

Model	LM8FC24M	LM12FC24M	LM16FC24M	LM25FC24M	LM35FC24M	LM50FC24M
Focal Length(mm)	8.5	12	16	25	35	50
Image Size(mm)	14.1×10.6(Φ17.6)	14.1×10.6(Φ17.6)	14.1×10.6(Φ17.6)	14.1×10.6(Φ17.6)	14.1×10.6(Φ17.6)	14.1×10.6(Φ17.6)
Iris Range(F-stop)	F2.5~F16	F1.8~F16	F1.8~F16	F1.8~F16	F1.8~F16	F1.8~F16
Focusing Range(m)	0.1~∞	0.1~∞	0.1~∞	0.1~∞	0.2~∞	0.2~∞
Control Iris	Manual	Manual	Manual	Manual	Manual	Manual
Focus	Manual	Manual	Manual	Manual	Manual	Manual
Shooting Range at M.O.D.(mm)	184(H)×138(V)	135(H)×101(V)	102(H)×77(V)	64(H)×48(V)	84(H)×63(V)	59(H)×44(V)
Angle of View	1.1 Inch 79.2×63.8 1 Inch 73.9×58.8 2/3 Inch 54.5×42.1	60.0×46.9 55.3×42.9 39.6×30.1	48.0×36.7 43.6×33.4 30.8×23.3	31.5×23.9 28.7×21.7 20.0×15.0	22.1×16.7 20.2×15.2 14.0×10.5	16.1×12.1 14.6×11.0 10.1×7.6
Resolution(Center, Corner)	200lp/mm, 100lp/mm	200lp/mm, 100lp/mm	200lp/mm, 100lp/mm	200lp/mm, 100lp/mm	200lp/mm, 100lp/mm	200lp/mm, 100lp/mm
TV Distortion(%)	0.55	0.26	-0.4	-0.3	0.01	-0.03
Back Focus in Air(mm)	12.9	14.5	11.9	13.3	15.5	14.8
Mount	C-mount	C-mount	C-mount	C-mount	C-mount	C-mount
Filter Thread(mm)	M62×P0.75	M49×P0.75	M35.5×P0.5	M35.5×P0.5	M40.5×P0.5	M40.5×P0.5
Size(mm)(∞)	Φ64×73.3	Φ51×73.8	Φ43×65.7	Φ45×67.9	Φ45×66	Φ45×74.5
Weight(g)	230	260	200	220	205	205
Temperature Range	-10°C~+50°C	-10°C~+50°C	-10°C~+50°C	-10°C~+50°C	-10°C~+50°C	-10°C~+50°C

Diagram of M.O.D. / Magnification Using A Close Up Ring

Model	LM6FC24M	LM8FC24M	LM12FC24M	LM16FC24M	LM25FC24M	LM35FC24M	LM50FC24M
(Non)M.O.D./Magnification	100mm/0.06×	100mm/0.08×	100mm/0.11×	100mm/0.14×	100mm/0.22×	200mm/0.17×	200mm/0.24×
(1mm Ring)M.O.D./Magnification	-	28mm/0.19×	50mm/0.18×	64mm/0.20×	82mm/0.26×	170mm/0.20×	184mm/0.26×
(5mm Ring)M.O.D./Magnification	-	-	-	20mm/0.45×	45mm/0.41×	106mm/0.31×	140mm/0.35×
(10mm Ring)M.O.D./Magnification	-	-	-	-	25mm/0.61×	71mm/0.46×	108mm/0.46×
(20mm Ring)M.O.D./Magnification	-	-	-	-	-	42mm/0.75×	76mm/0.68×

† Images may differ from the actual product.

† Images may differ from the actual product.

HC Series

Features of HC Series

- ▶ Wide product range: 9 lenses in HC series
- ▶ Up to 5 megapixels performance
- ▶ Excellent corner brightness
- ▶ High performance compact lenses
- ▶ Low distortion

✓ Compatible ◊ Suitable ✗ Incompatible

Model	Format Size(Inch)								
	4/3	1.2	1.1	1	1/1.2	2/3	1/1.8	1/2	1/3
LM4HC	✓	✓	✓	✓	✓	✓	✓	✓	✓
LM6HC	✓	✓	✓	✓	✓	✓	✓	✓	✓
LM8HC	✓	✓	✓	✓	✓	✓	✓	✓	✓
LM12HC	✓	✓	✓	✓	✓	✓	✓	✓	✓
LM16HC	✓	✓	✓	✓	✓	✓	✓	✓	✓
LM25HC	✓	✓	✓	✓	✓	✓	✓	✓	✓
LM35HC	✓	✓	✓	✓	✓	✓	✓	✓	✓
LM50HC	✓	✓	✓	✓	✓	✓	✓	✓	✓
LM75HC	✓	✓	✓	✓	✓	✓	✓	✓	✓

LM6HC

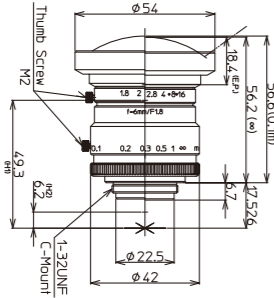

LM8HC

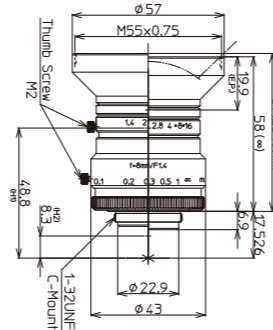

LM4HC

NEW

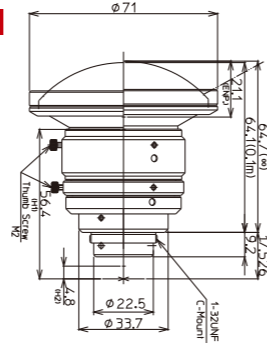

*Optional filter holder can be attached.

LM12HC

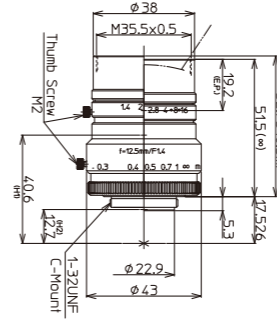

LM25HC

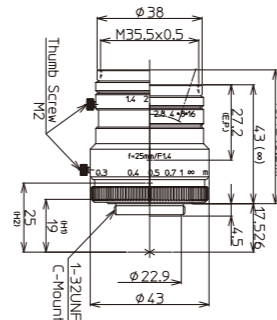

LM50HC

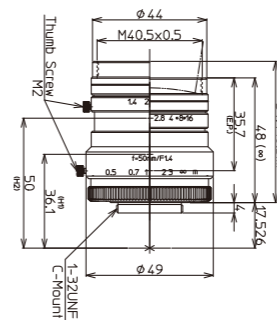

LM16HC

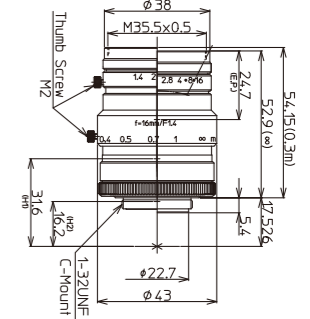

LM35HC

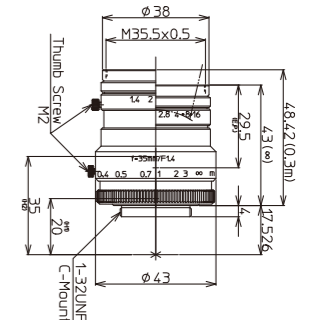

LM75HC

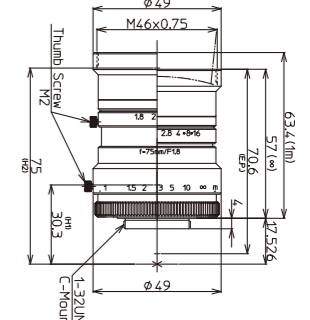

Model	LM4HC	LM6HC	LM8HC
Focal Length(mm)	4.7	6	8
Image Size(mm)	12.8×9.6 (Φ16)	12.8×9.6(Φ16)	12.8×9.6(Φ16)
Iris Range(F-stop)	F2.4-F11	F1.8-F11	F1.4-F16
Focusing Range(m)	0.1-∞	0.1-∞	0.1-∞
Control	Iris: Manual Focus: Manual	Iris: Manual Focus: Manual	Iris: Manual Focus: Manual
Shooting Range at M.O.D.(mm)	375.6(H)×272.1(V)	267.4(H)×196.3(V)	196.0(H)×143.2(V)
Angle of View (Degrees)	1 Inch: 112.2×95.4 2/3 Inch: 90.0×72.2 1/1.8 Inch: 77.4×60.8	1 Inch: 96.8×79.4 2/3 Inch: 74.1×58.0 1/1.8 Inch: 62.6×48.2	1 Inch: 79.4×63.0 2/3 Inch: 58.3×44.7 1/1.8 Inch: 48.5×36.9
Resolution(Center, Corner)	100lp/mm, 50lp/mm	120lp/mm, 80lp/mm	120lp/mm, 80lp/mm
TV Distortion(%)	-0.58	-0.2	-1.2
Back Focus in Air(mm)	9.0	11.1	11.2
Mount	C-mount	C-mount	C-mount
Filter Thread(mm)	*	-	M55×P0.75
Size(mm)(∞)	Φ71×64.7	Φ54×56.2	Φ57×58
Weight(g)	360	215	205
Temperature Range	-10°C~+50°C	-10°C~+50°C	-10°C~+50°C

*Optional filter holder can be attached.

Diagram of M.O.D. / Magnification Using A Close Up Ring

Model	LM4HC	LM6HC	LM8HC	LM12HC	LM16HC	LM25HC	LM35HC	LM50HC	LM75HC
(Non)M.O.D./Magnification	100mm/0.04×	100mm/0.05×	100mm/0.07×	300mm/0.04×	300mm/0.05×	300mm/0.08×	300mm/0.12×	500mm/0.11×	1000mm/0.078×
(1mm Ring)M.O.D./Magnification	-	-	-	93mm/0.12×	134mm/0.11×	200mm/0.12×	243mm/0.15×	424mm/0.13×	858mm/0.091×
(5mm Ring)M.O.D./Magnification	-	-	-	-	-	83mm/0.28×	138mm/0.26×	269mm/0.20×	553mm/0.14×
(10mm Ring)M.O.D./Magnification	-	-	-	-	-	-	91mm/0.40×	189mm/0.30×	389mm/0.21×
(20mm Ring)M.O.D./Magnification	-	-	-	-	-	-	-	124mm/0.50×	251mm/0.34×

† Images may differ from the actual product.

Model	LM12HC	LM16HC	LM25HC	LM35HC	LM50HC	LM75HC
Focal Length(mm)	12.5	16	25	35	50	75
Image Size(mm)	12.8×9.6(Φ16)	12.8×9.6(Φ16)	12.8×9.6(Φ16)	12.8×9.6(Φ16)	12.8×9.6(Φ16)	12.8×9.6(Φ16)
Iris Range(F-stop)	F1.4-F16	F1.4-F16	F1.4-F16	F1.4-F16	F1.4-F16	F1.8-F16
Focusing Range(m)	0.3-∞	0.3-∞	0.3-∞	0.3-∞	0.5-∞	1.0-∞
Control	Iris: Manual Focus: Manual	Iris: Manual Focus: Manual	Iris: Manual Focus: Manual	Iris: Manual Focus: Manual	Iris: Manual Focus: Manual	Iris: Manual Focus: Manual
Shooting Range at M.O.D.(mm)	330.6(H)×243.5(V)	251.5(H)×186.2(V)	160.7(H)×119.2(V)	110.1(H)×82.0(V)	121.8(H)×91.3(V)	165.5(H)×123.9(V)
Angle of View (Degrees)	1 Inch: 55.6×42.5 2/3 Inch: 39.1×29.5 1/1.8 Inch: 32.1×24.2	1 Inch: 44.3×33.6 2/3 Inch: 30.8×23.2 1/1.8 Inch: 25.3×19.0	1 Inch: 29.3×22.0 2/3 Inch: 20.2×15.1 1/1.8 Inch: 16.5×12.4	1 Inch: 20.9×15.8 2/3 Inch: 14.4×10.8 1/1.8 Inch: 11.8×8.8	1 Inch: 14.5×10.8 2/3 Inch: 10.0×7.5 1/1.8 Inch: 8.2×6.2	1 Inch: 9.7×7.3 2/3 Inch: 6.7×5.0 1/1.8 Inch: 5.5×4.1
Resolution(Center, Corner)	120lp/mm, 80lp/mm	120lp/mm, 80lp/mm	120lp/mm, 80lp/mm	120lp/mm, 80lp/mm	120lp/mm, 80lp/mm	120lp/mm, 80lp/mm
TV Distortion(%)	-1.58	-1.0	-1.0	-0.5	0.05	-0.2
Back Focus in Air(mm)	12.6	12.6	16.5	16.8	14.8	14.5
Mount	C-mount	C-mount	C-mount	C-mount	C-mount	C-mount
Filter Thread(mm)	M35.5×P0.5	M35.5×P0.5	M35.5×P0.5	M35.5×P0.5	M40.5×P0.5	M46×P0.75
Size(mm)(∞)	Φ43×51.5	Φ43×52.9	Φ43×43	Φ43×43	Φ49×48	Φ49×57
Weight(g)	160	150	135	135	210	195
Temperature Range	-10°C~+50°C	-10°C~+50°C	-10°C~+50°C	-10°C~+50°C	-10°C~+50°C	-10°C~+50°C

† Images may differ from the actual product.

HC-V Series

High Resolution FA/MV Lenses

Kowa's new HC-V series is made for use in high vibration and shock environments. With a design based on Kowa's standard 1" HC lenses, this new ruggedized megapixel lens series is ideal for applications that require increased durability and high optical performance.

✓ Compatible ◊ Suitable ✗ Incompatible

Model	Format Size(Inch)								
	4/3	1.2	1.1	1	1/1.2	2/3	1/1.8	1/2	1/3
LM8HC-V	✓	✓	✓	✓	✓	✓	✓	✓	✓
LM12HC-V	✓	✓	◊	✓	✓	✓	✓	✓	✓
LM16HC-V	✓	✓	✓	✓	✓	✓	✓	✓	✓
LM25HC-V	✓	✓	✓	✓	✓	✓	✓	✓	✓
LM35HC-V	✓	✓	✓	✓	✓	✓	✓	✓	✓
LM50HC-V	✓	✓	✓	✓	✓	✓	✓	✓	✓
LM75HC-V	✓	✓	✓	✓	✓	✓	✓	✓	✓

Features of HC-V Series

- ▶ Up to 5 megapixels performance
- ▶ Unique mechanical design to guard against strong vibration and shock.
- ▶ Two way reversible nut is utilized instead of thumb screws in order to tightly lock the focus adjustment ring in place.
- ▶ Utilizing two way reversible nut contributes to the prevention of screw dropping troubles.
- ▶ All internal glass elements are glued to the inside housing to improve stability.
- ▶ Interchangeable iris plates are used to select the F-stop.

Interchangeable Iris Plates

- The HC-V series uses interchangeable iris plates instead of mechanical iris diaphragms with moving blades. You can choose from four iris plates to adjust the F-stop.



Interchangeable Iris Plates

Focus Adjustment Procedure

- Unscrew the bottom ring of the outside body to adjust the focus to optimal position.
- Screw the red two way reversible nut on the center body towards the bottom ring to lock in the focus.



Two Way Reversible Nut

Instruction Video



LM8HC-V



RUGGED
Ruggedized lens

LM12HC-V



RUGGED
Ruggedized lens

LM16HC-V



RUGGED
Ruggedized lens

LM25HC-V



RUGGED
Ruggedized lens

LM35HC-V



RUGGED
Ruggedized lens

LM50HC-V

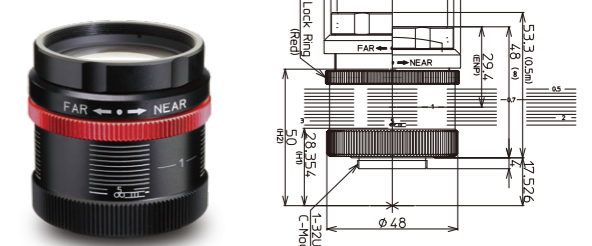

RUGGED
Ruggedized lens

Model	LM8HC-V	LM12HC-V	LM16HC-V	LM25HC-V	LM35HC-V	LM50HC-V
Focal Length (mm)	8	12.5	16	25	35	50
Image Size (mm)	12.8×9.6 (Φ16)	12.8×9.6 (Φ16)	12.8×9.6 (Φ16)	12.8×9.6 (Φ16)	12.8×9.6 (Φ16)	12.8×9.6 (Φ16)
Iris Range (F-stop)	F1.4 / F2.8 / F4 / F8	F1.4 / F2.8 / F4 / F8	F1.4 / F2.8 / F4 / F8	F1.4 / F2.8 / F4 / F8	F1.4 / F2.8 / F4 / F8	F1.4 / F2.8 / F4 / F8
Focusing Range (m)	0.1~∞	0.3~∞	0.3~∞	0.3~∞	0.3~∞	0.5~∞
Control	Iris	-	-	-	-	-
Focus	Manual	Manual	Manual	Manual	Manual	Manual
Shooting Range at M.O.D. (mm)	196.0(H)×143.0(V)	330.6(H)×243.5(V)	251.5(H)×186.2(V)	160.7(H)×119.2(V)	110.1(H)×82.0(V)	121.8(H)×91.3(V)
Angle of View	1 Inch 79.7×63.0 2/3 Inch 58.3×44.7	55.6×42.5 39.1×29.5	44.3×33.6 30.8×23.2	29.3×22.0 20.2×15.1	20.9×15.8 14.4×10.8	14.5×10.8 10.0×7.5
Resolution(Center, Corner)	120lp/mm, 80lp/mm	120lp/mm, 80lp/mm	120lp/mm, 80lp/mm	120lp/mm, 80lp/mm	120lp/mm, 80lp/mm	120lp/mm, 80lp/mm
TV Distortion (%)	-1.2	-1.58	-1.0	-1.0	-0.5	0.05
Back Focus in Air(mm)	11.2	12.6	12.6	16.5	16.8	14.8
Mount	C-mount	C-mount	C-mount	C-mount	C-mount	C-mount
Filter Thread (mm)	M55×P0.75	M35.5×P0.5	M35.5×P0.5	M35.5×P0.5	M35.5×P0.5	M40.5×P0.5
Size (mm)(∞)	Φ58×58	Φ44×51.5	Φ44×53	Φ44×43	Φ46×44.1	Φ50×48
Weight(g)	183	130	120	104	133	170
Temperature Range	-10°C~+50°C	-10°C~+50°C	-10°C~+50°C	-10°C~+50°C	-10°C~+50°C	-10°C~+50°C

† Images may differ from the actual product.

† Images may differ from the actual product.

JC10M Series

High Resolution FA/MV Lenses

✓ Compatible ◇ Suitable — Incompatible

Model	Format Size(Inch)								
	4/3	1.2	1.1	1	1/1.2	2/3	1/1.8	1/2	1/3
LM5JC10M	—	—	—	—	—	✓	✓	✓	✓
LM8JC10M	—	—	—	—	—	✓	✓	✓	✓
LM12JC10M	—	—	—	—	—	✓	✓	✓	✓
LM16JC10M	—	—	—	—	◇	✓	✓	✓	✓
LM25JC10M	—	—	—	—	—	✓	✓	✓	✓
LM35JC10M	—	—	—	—	◇	✓	✓	✓	✓
LM50JC10M	—	—	—	—	◇	✓	✓	✓	✓

Features of JC10M Series

- ▶ 200lp/mm center resolution and low distortion maximize performance of high-end inspection.
- ▶ Incorporating Kowa's wide-band multi-coating and floating mechanism system, the JC10M lens series greatly reduces chromatic aberration from close distance to infinity and maintains a high transmission from visible to NIR.
- ▶ Short minimum object distance and compact design using aspherical lenses (5 models/f=5~25mm) allow for easy installation in compact machine vision systems.



LM8JC10M



LO-DIS FLOAT XD WBMC
Low Distortion Floating Extra Low Dispersion Wide-Band Multi-Coating

LM12JC10M



LO-DIS FLOAT XD WBMC
Low Distortion Floating Extra Low Dispersion Wide-Band Multi-Coating

LM16JC10M



LO-DIS FLOAT WBMC
Low Distortion Floating Wide-Band Multi-Coating

LM25JC10M



LO-DIS FLOAT WBMC
Low Distortion Floating Wide-Band Multi-Coating

LM35JC10M



LO-DIS FLOAT WBMC
Low Distortion Floating Wide-Band Multi-Coating

LM50JC10M



LO-DIS FLOAT XD WBMC
Low Distortion Floating Extra Low Dispersion Wide-Band Multi-Coating

LM5JC10M

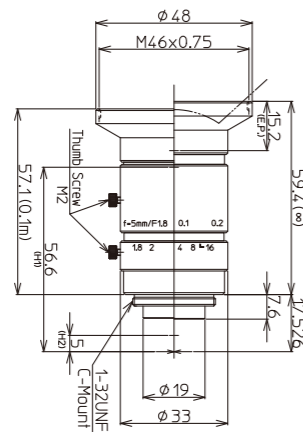

Model	LM5JC10M
Focal Length(mm)	5
Image Size(mm)	8.8×6.6(Φ11)
Iris Range(F-stop)	F1.8-F16
Focusing Range(m)	0.1~∞
Control Iris	Manual
Focus	Manual
Shooting Range at M.O.D.(mm)	197.0(H)×147.0(V)
Angle of View	2/3 Inch 82.2×66.5 1/1.8 Inch 71.1×56.5 1/2 Inch 64.9×51.1
Resolution(Center, Corner)	200lp/mm, 160lp/mm
TV Distortion(%)	-0.33
Back Focus in Air(mm)	10.3
Mount	C-mount
Filter Thread(mm)	M46×P0.75
Size(mm)(∞)	Φ48×59.4
Weight(g)	120
Temperature Range	-10°C~+50°C

Model	LM8JC10M	LM12JC10M	LM16JC10M	LM25JC10M	LM35JC10M	LM50JC10M
Focal Length(mm)	8.5	12	16	25	35	50
Image Size(mm)	8.8×6.6(Φ11)	8.8×6.6(Φ11)	8.8×6.6(Φ11)	8.8×6.6(Φ11)	8.8×6.6(Φ11)	8.8×6.6(Φ11)
Iris Range(F-stop)	F1.8-F22	F1.8-F11	F1.8-F16	F1.8-F16	F2.0-F16	F2.8-F16
Focusing Range(m)	0.1~∞	0.1~∞	0.1~∞	0.1~∞	0.1~∞	0.1~∞
Control Iris	Manual	Manual	Manual	Manual	Manual	Manual
Focus	Manual	Manual	Manual	Manual	Manual	Manual
Shooting Range at M.O.D.(mm)	133.2(H)×99.6(V)	80.7(H)×60.2(V)	61.1(H)×45.7(V)	36.7(H)×27.5(V)	23.4(H)×17.6(V)	19.1(H)×14.3(V)
Angle of View	2/3 Inch 54.0×41.9 1/1.8 Inch 45.3×34.8 1/2 Inch 40.8×31.2	39.1×29.8 32.4×24.6 28.9×21.9	30.0×22.7 24.7×18.6 22.0×16.6	20.0×15.1 16.4×12.3 14.6×11.0	14.3×10.8 11.7×8.8 10.4×7.8	10.1×7.6 8.2×6.1 7.3×5.5
Resolution(Center, Corner)	200lp/mm, 160lp/mm	200lp/mm, 160lp/mm	200lp/mm, 160lp/mm	200lp/mm, 160lp/mm	200lp/mm, 160lp/mm	200lp/mm, 160lp/mm
TV Distortion(%)	0.31	-0.12	-0.20	-0.09	0.05	-0.02
Back Focus in Air(mm)	12.1	13.9	14.6	17.9	14.2	12.8
Mount	C-mount	C-mount	C-mount	C-mount	C-mount	C-mount
Filter Thread(mm)	M34×P0.5	M25.5×P0.5	M25.5×P0.5	M25.5×P0.5	M34×P0.5	M30.5×P0.5
Size(mm)(∞)	Φ36×56.0	Φ33×53.5	Φ33×47.5	Φ33×45.5	Φ43×49	Φ38×77
Weight(g)	115	105	90	95	160	170
Temperature Range	-10°C~+50°C	-10°C~+50°C	-10°C~+50°C	-10°C~+50°C	-10°C~+50°C	-10°C~+50°C

Diagram of M.O.D. / Magnification Using A Close Up Ring

Model	LM5JC10M	LM8JC10M	LM12JC10M	LM16JC10M	LM25JC10M	LM35JC10M	LM50JC10M
(Non)M.O.D./Magnification	100mm/0.05×	100mm/0.07×	100mm/0.11×	100mm/0.15×	100mm/0.24×	100mm/0.38×	100mm/0.46×
(1mm Ring)M.O.D./Magnification	-	20mm/0.20×	48mm/0.19×	61mm/0.21×	79mm/0.28×	85mm/0.40×	91mm/0.48×
(5mm Ring)M.O.D./Magnification	-	-	-	18mm/0.45×	46mm/0.44×	65mm/0.50×	76mm/0.58×
(10mm Ring)M.O.D./Magnification	-	-	-	-	29mm/0.63×	49mm/0.62×	64mm/0.70×
(20mm Ring)M.O.D./Magnification	-	-	-	-	-	31mm/0.87×	49mm/0.94×

† Images may differ from the actual product.

† Images may differ from the actual product.

JC5M2 Series

Features of JC5M2 Series

- ▶ Incorporating Kowa's floating mechanism system, the JC5M2 lens series greatly reduces chromatic aberration from close distance to infinity.
- ▶ Good performance at the edge as well as the center.
- ▶ Available in F1.4. (LM12JC5M2 and LM16-JC5M2)

✓ Compatible ◊ Suitable — Incompatible

Model	Format Size(Inch)								
	4/3	1.2	1.1	1	1/1.2	2/3	1/1.8	1/2	1/3
LM12JC5M2	—	—	—	—	—	✓	✓	✓	✓
LM16JC5M2	—	—	—	—	—	✓	✓	✓	✓
LM25JC5M2	—	—	—	—	◊	✓	✓	✓	✓
LM35JC5M2	—	—	—	◊	◊	✓	✓	✓	✓



LM16JC5M2

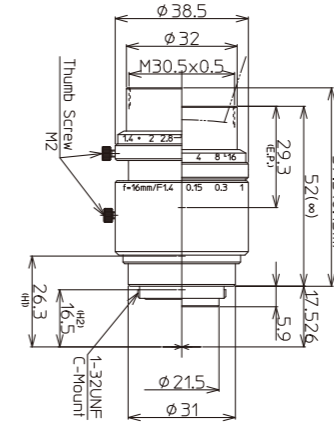

LO-DIS FLOAT
Low Distortion Floating

LM25JC5M2

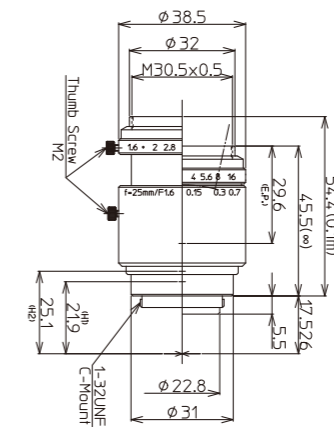

LO-DIS FLOAT
Low Distortion Floating

LM35JC5M2

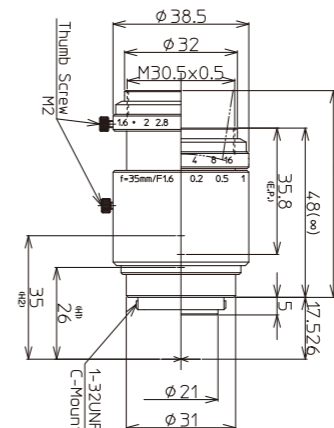

LO-DIS FLOAT
Low Distortion Floating

Model	LM16JC5M2
Focal Length(mm)	16
Image Size(mm)	8.8×6.6(Φ11)
Iris Range(F-stop)	F1.4~F16
Focusing Range(m)	0.1~∞
Control	Iris Manual Focus Manual
Shooting Range at M.O.D.(mm)	64.6(H)×48.4(V)
Angle of View	2/3 Inch 29.9×22.7 1/1.8 Inch 24.7×18.6 1/2 Inch 22.0×16.6
Resolution(Center, Corner)	160lp/mm, 125lp/mm
TV Distortion(%)	0.03
Back Focus in Air(mm)	11.6
Mount	C-mount
Filter Thread(mm)	M30.5×P0.5
Size(mm)(∞)	Φ38.5×52
Weight(g)	125
Temperature Range	-10°C~+50°C

Model	LM25JC5M2
Focal Length(mm)	25
Image Size(mm)	8.8×6.6(Φ11)
Iris Range(F-stop)	F1.6~F16
Focusing Range(m)	0.1~∞
Control	Iris Manual Focus Manual
Shooting Range at M.O.D.(mm)	35.1(H)×26.3(V)
Angle of View	2/3 Inch 19.9×15.0 1/1.8 Inch 16.4×12.3 1/2 Inch 14.6×10.9
Resolution(Center, Corner)	160lp/mm, 125lp/mm
TV Distortion(%)	-0.01
Back Focus in Air(mm)	11.2
Mount	C-mount
Filter Thread(mm)	M30.5×P0.5
Size(mm)(∞)	Φ38.5×45.5
Weight(g)	115
Temperature Range	-10°C~+50°C

Model	LM35JC5M2
Focal Length(mm)	35
Image Size(mm)	8.8×6.6(Φ11)
Iris Range(F-stop)	F1.6~F16
Focusing Range(m)	0.18~∞
Control	Iris Manual Focus Manual
Shooting Range at M.O.D.(mm)	42.1(H)×31.6(V)
Angle of View	2/3 Inch 14.3×10.8 1/1.8 Inch 11.7×8.8 1/2 Inch 10.4×7.8
Resolution(Center, Corner)	160lp/mm, 125lp/mm
TV Distortion(%)	-0.03
Back Focus in Air(mm)	12.2
Mount	C-mount
Filter Thread(mm)	M30.5×P0.5
Size(mm)(∞)	Φ38.5×48
Weight(g)	120
Temperature Range	-10°C~+50°C

LM12JC5M2

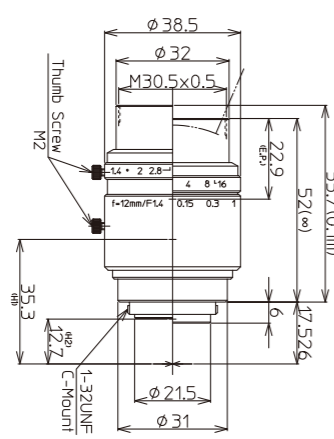

Model	LM12JC5M2
Focal Length(mm)	12.5
Image Size(mm)	8.8×6.6(Φ11)
Iris Range(F-stop)	F1.4~F16
Focusing Range(m)	0.1~∞
Control	Iris Manual Focus Manual
Shooting Range at M.O.D.(mm)	81.4(H)×60.9(V)
Angle of View	2/3 Inch 38.4×29.2 1/1.8 Inch 31.7×24.0 1/2 Inch 28.4×21.4
Resolution(Center, Corner)	160lp/mm, 125lp/mm
TV Distortion(%)	-0.06
Back Focus in Air(mm)	11.5
Mount	C-mount
Filter Thread(mm)	M30.5×P0.5
Size(mm)(∞)	Φ38.5×52
Weight(g)	130
Temperature Range	-10°C~+50°C

LO-DIS FLOAT
Low Distortion Floating

Diagram of M.O.D. / Magnification Using A Close Up Ring

Model	LM12JC5M2	LM16JC5M2	LM25JC5M2	LM35JC5M2
(Non)M.O.D./Magnification	100mm/0.109×	100mm/0.137×	100mm/0.251×	180mm/0.209×
(1mm Ring)M.O.D./Magnification	50mm/0.184×	62mm/0.195×	86mm/0.288×	160mm/0.235×
(5mm Ring)M.O.D./Magnification	-	-	54mm/0.434×	109mm/0.341×
(10mm Ring)M.O.D./Magnification	-	-	-	78mm/0.470×
(20mm Ring)M.O.D./Magnification	-	-	-	49mm/0.728×

† Images may differ from the actual product.

† Images may differ from the actual product.

JC5MC Series NEW

High Resolution FA/MV Lenses

✓ Compatible ◇ Suitable — Incompatible

Model	Format Size(Inch)								
	4/3	1.2	1.1	1	1/1.2	2/3	1/1.8	1/2	1/3
LM8JC5MC	—	—	—	—	—	✓	✓	✓	✓
LM12JC5MC	—	—	—	—	—	✓	✓	✓	✓
LM16JC5MC	—	—	—	—	—	✓	✓	✓	✓
LM25JC5MC	—	—	—	—	—	✓	✓	✓	✓

Features of JC5MC Series

- ▶ One of the industry's smallest and lightest 5 megapixel lenses.
- ▶ Roughly half the size of Kowa's current 2/3" 5MP JC5M2 series lenses.
- ▶ Unique mechanical design to guard against strong vibration and shock.
- ▶ Easy to change the iris to the marked F-number by click-type iris mechanism. (F2.8, 4, 5.6, 8 and 16)
- ▶ Focal length 35mm and 50mm : To Be Released in 2021



LM12JC5MC NEW

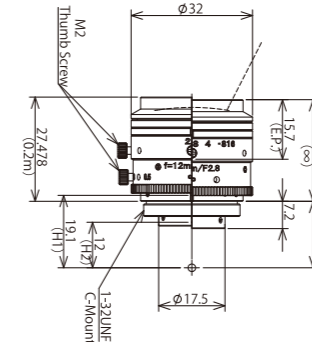

LM16JC5MC NEW

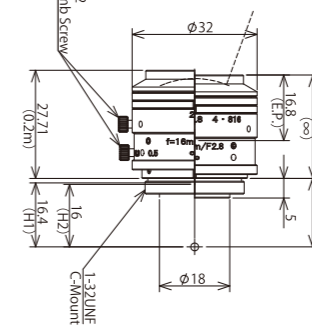

LM25JC5MC NEW

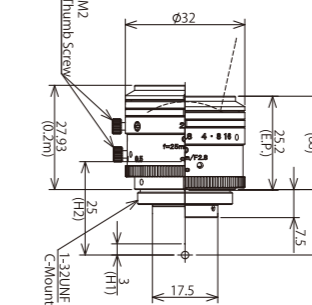

LM8JC5MC NEW

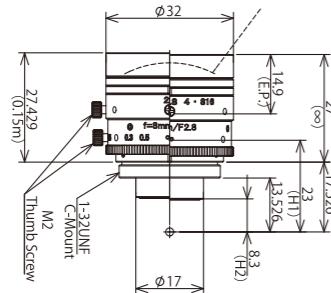

Model	LM8JC5MC
Focal Length(mm)	8
Image Size(mm)	8.8×6.6(Φ11)
Iris Range(F-stop)	F2.8~F16
Focusing Range(m)	0.15~∞
Control	Iris: Manual Focus: Manual
Shooting Range at M.O.D.(mm)	178.0(H)×132.0(V)
Angle of View	2/3 Inch: 57.6×44.4 1/1.8 Inch: 48.1×36.7 1/2 Inch: 43.1×32.8
Resolution(Center, Corner)	160lp/mm, 100lp/mm
TV Distortion(%)	-0.85
Back Focus in Air(mm)	10.8
Mount	C-mount
Filter Thread(mm)	M30.5×P0.5
Size(mm)(∞)	Φ32×27
Weight(g)	55
Temperature Range	-10°C~+50°C

Model	LM12JC5MC
Focal Length(mm)	12
Image Size(mm)	8.8×6.6(Φ11)
Iris Range(F-stop)	F2.8~F16
Focusing Range(m)	0.2~∞
Control	Iris: Manual Focus: Manual
Shooting Range at M.O.D.(mm)	159.0(H)×118.0(V)
Angle of View	2/3 Inch: 41.0×31.2 1/1.8 Inch: 33.9×25.6 1/2 Inch: 30.3×22.8
Resolution(Center, Corner)	160lp/mm, 100lp/mm
TV Distortion(%)	-0.27
Back Focus in Air(mm)	12.6
Mount	C-mount
Filter Thread(mm)	*
Size(mm)(∞)	Φ32×26.8
Weight(g)	55
Temperature Range	-10°C~+50°C

*Optional filter holder can be attached.(M30.5×P0.5)

Model	LM16JC5MC
Focal Length(mm)	16
Image Size(mm)	8.8×6.6(Φ11)
Iris Range(F-stop)	F2.8~F16
Focusing Range(m)	0.2~∞
Control	Iris: Manual Focus: Manual
Shooting Range at M.O.D.(mm)	117.0(H)×88.0(V)
Angle of View	2/3 Inch: 30.9×23.4 1/1.8 Inch: 25.5×19.2 1/2 Inch: 22.7×17.2
Resolution(Center, Corner)	160lp/mm, 100lp/mm
TV Distortion(%)	-0.04
Back Focus in Air(mm)	14.7
Mount	C-mount
Filter Thread(mm)	*
Size(mm)(∞)	Φ32×26.5
Weight(g)	55
Temperature Range	-10°C~+50°C

*Optional filter holder can be attached.(M30.5×P0.5)

Model	LM25JC5MC
Focal Length(mm)	25
Image Size(mm)	8.8×6.6(Φ11)
Iris Range(F-stop)	F2.8~F16
Focusing Range(m)	0.2~∞
Control	Iris: Manual Focus: Manual
Shooting Range at M.O.D.(mm)	75.0(H)×56.0(V)
Angle of View	2/3 Inch: 20.0×15.0 1/1.8 Inch: 16.4×12.4 1/2 Inch: 14.6×11.0
Resolution(Center, Corner)	160lp/mm, 100lp/mm
TV Distortion(%)	0.11
Back Focus in Air(mm)	11.7
Mount	C-mount
Filter Thread(mm)	*
Size(mm)(∞)	Φ32×25
Weight(g)	55
Temperature Range	-10°C~+50°C

*Optional filter holder can be attached.(M30.5×P0.5)

Diagram of M.O.D. / Magnification Using A Close Up Ring

Model	LM8JC5MC	LM12JC5MC	LM16JC5MC	LM25JC5MC
(Non)M.O.D./Magnification	150mm/0.05×	200mm/0.06×	200mm/0.08×	200mm/0.12×
(1mm Ring)M.O.D./Magnification	35mm/0.18×	75mm/0.13×	105mm/0.14×	145mm/0.16×
(5mm Ring)M.O.D./Magnification	-	-	-	66mm/0.32×
(10mm Ring)M.O.D./Magnification	-	-	-	-
(20mm Ring)M.O.D./Magnification	-	-	-	-

† Images may differ from the actual product.

† Images may differ from the actual product.

NCM/JCM Series

High Resolution FA/MV Lenses

Features of WIDE NCM/JCM Series

- ▶ Super wide optical design
 - ▶ Large angle of view
 - ▶ Expansion angle
(Horizontal angle 82degree, Vertical angle 66degree)
- † 2/3" model: LM5JCM, 1/1.8" model: LM3NCM

Low distortion

- ▶ Reduces the distortion to corner
- † LM5JCM: Under 0.5%, LM3NCM: Under 0.4% (TV distortion)

High quality

- ▶ Adapts to 2 megapixel cameras
- ▶ Improves center and corner resolution
- ▶ High transmittance

✓ Compatible ◇ Suitable — Incompatible

Model	Format Size(Inch)								
	4/3	1.2	1.1	1	1/1.2	2/3	1/1.8	1/2	1/3
LM3NCM	—	—	—	—	—	—	✓	✓	✓
LM6NCM	—	—	—	—	—	—	—	◇	✓
LM5JCM	—	—	—	—	—	—	✓	✓	✓



Corner image comparison
(Super wide angle lens vs. Standard lens)

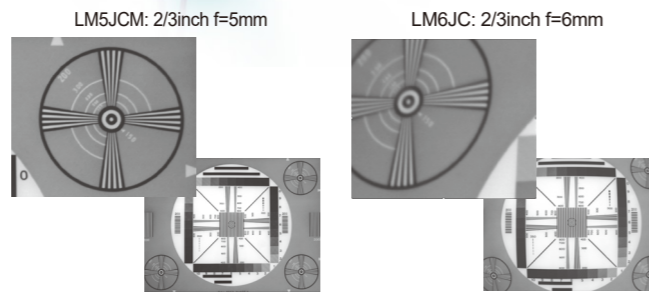

Distortion comparison at short distance object

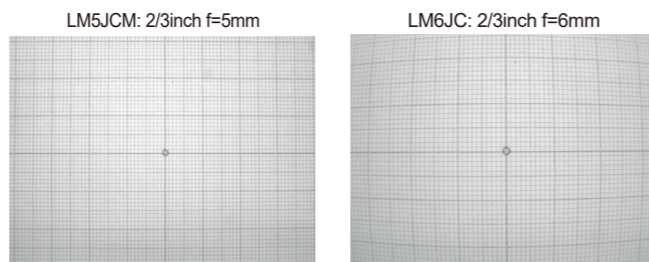

Capture image taken by 2megapixel camera

† Images may differ from the actual product.

LM3NCM



LO-DIS
Low Distortion

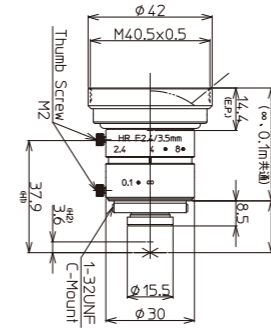

LM6NCM



LO-DIS
Low Distortion

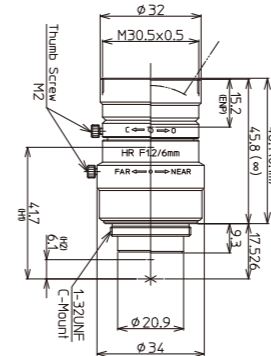

LM5JCM



LO-DIS
Low Distortion

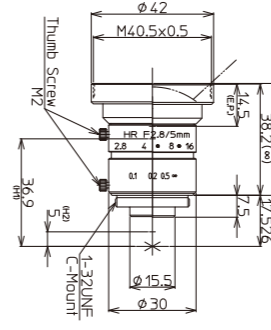

Model	LM3NCM
Focal Length(mm)	3.5
Image Size(mm)	7.2×5.4(Φ9)
Iris Range(F-stop)	F2.4~F14
Focusing Range(m)	0.1~∞
Control	Iris: Manual Focus: Manual
Shooting Range at M.O.D.(mm)	226.3(H)×171.4(V)
Angle of View	2/3 inch: — 1/1.8 inch: 89.0×73.8 (Degrees) 1/2 inch: 82.4×66.9 1/3 inch: 66.9×52.7
Resolution(Center, Corner)	120lp/mm, 100lp/mm
TV Distortion(%)	0.4
Back Focus in Air(mm)	9.7
Mount	C-mount
Filter Thread(mm)	M40.5×P0.5
Size(mm)(∞)	Φ42×38.2
Weight(g)	85
Temperature Range	-10°C~+50°C

Model	LM6NCM
Focal Length(mm)	6
Image Size(mm)	6.4×4.8(Φ8)
Iris Range(F-stop)	F1.2~Close
Focusing Range(m)	0.1~∞
Control	Iris: Manual Focus: Manual
Shooting Range at M.O.D.(mm)	122.2(H)×91.0(V)
Angle of View	2/3 inch: — 1/1.8 inch: — (Degrees) 1/2 inch: 56.2×43.5 1/3 inch: 43.5×33.2
Resolution(Center, Corner)	120lp/mm, 100lp/mm
TV Distortion(%)	-0.2
Back Focus in Air(mm)	8.2
Mount	C-mount
Filter Thread(mm)	M30.5×P0.5
Size(mm)(∞)	Φ34×45.8
Weight(g)	100
Temperature Range	-10°C~+50°C

Model	LM5JCM
Focal Length(mm)	5
Image Size(mm)	8.8×6.6(Φ11)
Iris Range(F-stop)	F2.8~F16
Focusing Range(m)	0.1~∞
Control	Iris: Manual Focus: Manual
Shooting Range at M.O.D.(mm)	200.8(H)×150.8(V)
Angle of View	2/3 inch: 82.4×66.9 1/1.8 inch: 71.7×57.1 (Degrees) 1/2 inch: 65.2×51.3 1/3 inch: —
Resolution(Center, Corner)	120lp/mm, 100lp/mm
TV Distortion(%)	0.5
Back Focus in Air(mm)	10.0
Mount	C-mount
Filter Thread(mm)	M40.5×P0.5
Size(mm)(∞)	Φ42×38.2
Weight(g)	84
Temperature Range	-10°C~+50°C

† Images may differ from the actual product.

JC1MS Series

Features of JC1MS Series

- ▶ Wide product range: 9 lenses in JC1MS series
- ▶ Equivalent to 2 megapixels performance
- ▶ World standard and popular lens series
- ▶ Excellent corner brightness
- ▶ Low distortion

✓ Compatible ◊ Suitable — Incompatible

Model	Format Size(Inch)								
	4/3	1.2	1.1	1	1/1.2	2/3	1/1.8	1/2	1/3
LM5JCM	—	—	—	—	—	—	—	—	—
LM8JC1MS	—	—	—	—	—	—	—	—	—
LM12JC1MS	—	—	—	—	—	—	—	—	—
LM16JC1MS	—	—	—	—	—	—	—	—	—
LM25JC1MS	—	—	—	—	—	—	—	—	—
LM35JC1MS	—	—	—	—	—	—	—	—	—
LM50JC1MS	—	—	—	—	—	—	—	—	—
LM75JC1MS	—	—	—	—	—	—	—	—	—
LM100JC1MS	—	—	—	—	—	—	—	—	—

LM5JCM

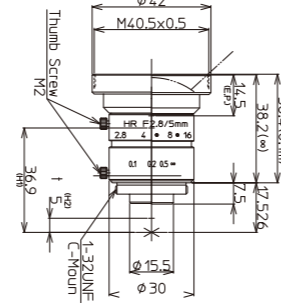

LO-DIS
Low Distortion

LM8JC1MS



LO-DIS
Low Distortion

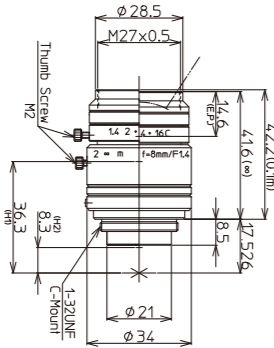

LM12JC1MS



LO-DIS
Low Distortion

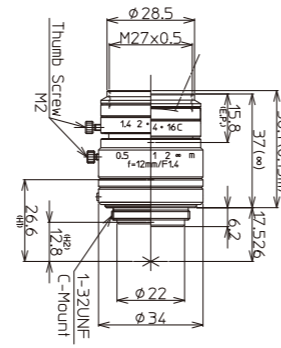

LM16JC1MS



LO-DIS FLOAT
Low Distortion Floating

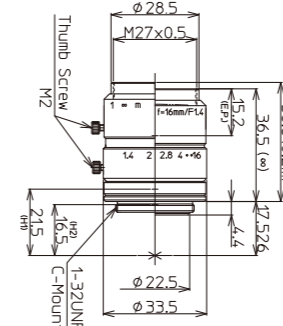

LM25JC1MS



LO-DIS FLOAT
Low Distortion Floating

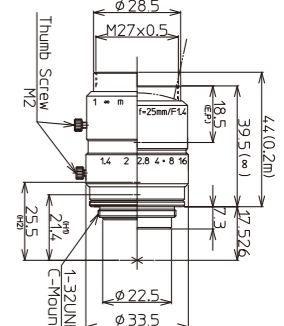

LM35JC1MS



FLOAT
Floating

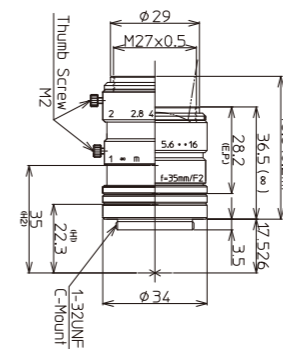

LM50JC1MS



LO-DIS FLOAT
Low Distortion Floating

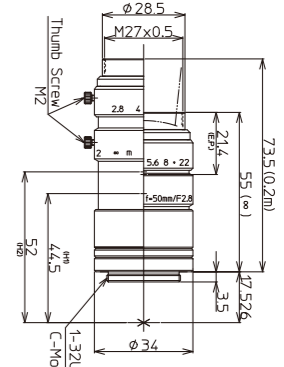

LM75JC1MS



FLOAT
Floating

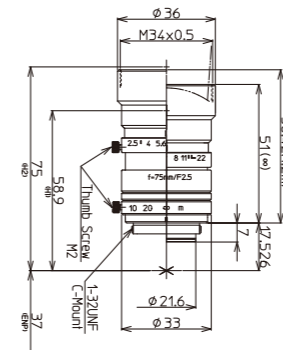

LM100JC1MS



FLOAT
Floating

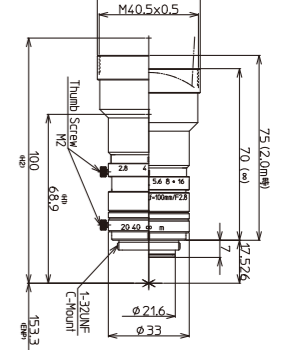

Model	LM5JCM	LM8JC1MS	LM12JC1MS
Focal Length(mm)	5	8	12
Image Size(mm)	8.8×6.6(Φ11)	8.8×6.6(Φ11)	8.8×6.6(Φ11)
Iris Range(F-stop)	F2.8-F16	F1.4-Close	F1.4-Close
Focusing Range(m)	0.1-∞	0.1-∞	0.15-∞
Control Iris	Manual	Manual	Manual
Focus	Manual	Manual	Manual
Shooting Range at M.O.D.(mm)	200.8(H)×150.8(V)	120.3(H)×90.0(V)	110.0(H)×82.5(V)
Angle of View 2/3 Inch	82.4×66.9	56.5×43.9	38.3×29.1
View 1/1.8 Inch	71.7×57.1	47.4×36.3	31.7×24.0
(Degrees) 1/2 Inch	65.2×51.3	42.6×32.5	28.3×21.4
Resolution(Center, Corner)	120lp/mm, 100lp/mm	120lp/mm, 100lp/mm	120lp/mm, 100lp/mm
TV Distortion(%)	0.5	-0.6	-0.07
Back Focus in Air(mm)	10.0	9.74	11.7
Mount	C-mount	C-mount	C-mount
Filter Thread(mm)	M40.5×P0.5	M27×P0.5	M27×P0.5
Size(mm)(∞)	Φ42×38.2	Φ34×41.6	Φ34×37
Weight(g)	84	90	85
Temperature Range	-10°C~+50°C	-10°C~+50°C	-10°C~+50°C

Diagram of M.O.D. / Magnification Using A Close Up Ring

Model	LM5JCM	LM8JC1MS	LM12JC1MS	LM16JC1MS	LM25JC1MS	LM35JC1MS	LM50JC1MS	LM75JC1MS	LM100JC1MS
(Non)M.O.D./Magnification	100mm/0.04×	100mm/0.07×	150mm/0.08×	200mm/0.08×	200mm/0.12×	200mm/0.18×	200mm/0.30×	1200mm/0.07×	2000mm/0.05×
(1mm Ring)M.O.D./Magnification	-	30mm/0.20×	70mm/0.16×	110mm/0.14×	150mm/0.16×	175mm/0.21×	190mm/0.32×	1010mm/0.08×	1700mm/0.06×
(5mm Ring)M.O.D./Magnification	-	-	-	-	73mm/0.31×	115mm/0.32×	160mm/0.39×	630mm/0.13×	1060mm/0.10×
(10mm Ring)M.O.D./Magnification	-	-	-	-	-	81mm/0.46×	135mm/0.48×	440mm/0.20×	740mm/0.15×
(20mm Ring)M.O.D./Magnification	-	-	-	-	-	51mm/0.73×	105mm/0.65×	285mm/0.34×	480mm/0.25×

† Images may differ from the actual product.

Model	LM16JC1MS	LM25JC1MS	LM35JC1MS	LM50JC1MS	LM75JC1MS	LM100JC1MS
Focal Length(mm)	16	25	35	50	75	100
Image Size(mm)	8.8×6.6(Φ11)	8.8×6.6(Φ11)	8.8×6.6(Φ11)	8.8×6.6(Φ11)	8.8×6.6(Φ11)	8.8×6.6(Φ11)
Iris Range(F-stop)	F1.4-F16	F1.4-F16	F2.0-F16	F2.8-F22	F2.5-F22	F2.8-F32
Focusing Range(m)	0.2-∞	0.2-∞	0.2-∞	0.2-∞	1.2-∞	2.0-∞
Control Iris	Manual	Manual	Manual	Manual	Manual	Manual
Focus	Manual	Manual	Manual	Manual	Manual	Manual
Shooting Range at M.O.D.(mm)	112.8(H)×84.4(V)	71.1(H)×53.3(V)	47.9(H)×35.8(V)	29.3(H)×21.9(V)	132.6(H)×99.6(V)	168.8(H)×126.6(V)
Angle of View 2/3 Inch	30.0×22.7	19.6×14.8	14.4×10.8	9.6×7.2	6.7×5.0	5.0×3.8
View 1/1.8 Inch	24.7×18.6	16.1×12.1	11.8×8.8	7.9×5.9	5.5×4.1	4.1×3.1
(Degrees) 1/2 Inch	21.8×16.4	14.0×10.5	10.5×7.9	7.0×5.2	4.9×3.7	3.7×2.8
Resolution(Center, Corner)	120lp/mm, 100lp/mm	120lp/mm, 100lp/mm	120lp/mm, 100lp/mm	120lp/mm, 100lp/mm	120lp/mm, 80lp/mm	120lp/mm, 80lp/mm
TV Distortion(%)	-0.05	-0.04	-0.2	-0.03	-0.1	-0.05
Back Focus in Air(mm)	13.1	11.7	20.1	35.5	18.0	19.0
Mount	C-mount	C-mount	C-mount	C-mount	C-mount	C-mount
Filter Thread(mm)	M27×P0.5	M27×P0.5	M27×P0.5	M27×P0.5	M34×P0.5	M40.5×P0.5
Size(mm)(∞)	Φ33.5×36.5	Φ33.5×39.5	Φ34×36.5	Φ34×55	Φ36×51	Φ42×70
Weight(g)	85	90	70	95	105	145
Temperature Range	-10°C~+50°C	-10°C~+50°C	-10°C~+50°C	-10°C~+50°C	-10°C~+50°C	-10°C~+50°C

† Images may differ from the actual product.

JCM-V Series

High Resolution FA/MV Lenses

Kowa's new JCM-V Series is designed for use in high vibration and shock environments. With a design based on Kowa's standard 2/3" JC1MS lenses, this new ruggedized megapixel lens series is ideal for applications that require increased durability and high optical performance.

Features of JCM-V Series

- ▶ Equivalent to 2 megapixels performance
- ▶ Two way reversible nut is utilized instead of thumb screws in order to tightly lock the focus adjustment ring in place.
- ▶ Utilizing two way reversible nut contributes to the prevention of screw dropping troubles.

- ▶ Interchangeable iris plates are used to select the F-stop.
- ▶ Unique mechanical design to guard against strong vibration and shock.
- ▶ All internal glass elements are glued to the inside housing to improve stability.

Interchangeable Iris Plates

- The JCM-V series uses interchangeable iris plates instead of mechanical iris diaphragms with moving blades. You can choose from four iris plates to adjust the F-stop.



Interchangeable Iris Plates

Focus Adjustment Procedure

- Unscrew the bottom ring of the outside body to adjust the focus to optimal position.
- Screw the red two way reversible nut on the center body towards the bottom ring to lock in the focus.



Instruction Video



Two Way Reversible Nut

Model	Format Size(Inch)								
	4/3	1.2	1.1	1	1/1.2	2/3	1/1.8	1/2	1/3
LM5JCM-V	-	-	-	-	✓	✓	✓	✓	✓
LM8JCM-V	-	-	-	-	✓	✓	✓	✓	✓
LM12JCM-V	-	-	-	-	✓	✓	✓	✓	✓
LM16JCM-V	-	-	-	-	✓	✓	✓	✓	✓
LM25JCM-V	-	-	-	-	✓	✓	✓	✓	✓
LM35JCM-V	-	-	◇	◇	◇	◇	◇	◇	◇
LM50JCM-V	-	◇	◇	◇	◇	◇	◇	◇	◇



LM8JCM-V



LO-DIS RUGGED Low Distortion Ruggedized lens

LM12JCM-V



LO-DIS RUGGED Low Distortion Ruggedized lens

LM16JCM-V



LO-DIS RUGGED Low Distortion Ruggedized lens

LM25JCM-V



LO-DIS RUGGED Low Distortion Ruggedized lens

LM35JCM-V



LO-DIS RUGGED Low Distortion Ruggedized lens

LM50JCM-V



LO-DIS RUGGED Low Distortion Ruggedized lens

LM5JCM-V

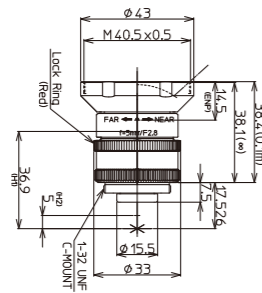

LO-DIS RUGGED Low Distortion Ruggedized lens

Model	LM5JCM-V
Focal Length (mm)	5
Image Size (mm)	8.8×6.6 (Φ11)
Iris Range (F-stop)	F2.8 / F4 / F5.6 / F8
Focusing Range (m)	0.1~∞
Control Iris	-
Focus	Manual
Shooting Range at M.O.D. (mm)	200.8(H)×150.8(V)
Angle of View (Degrees)	2/3 Inch: 82.4×66.9 1/1.8 Inch: 71.7×57.1 1/2 Inch: 65.2×51.3
Resolution(Center, Corner)	120lp/mm, 100lp/mm
TV Distortion (%)	0.5
Back Focus in Air(mm)	10.0
Mount	C-mount
Filter Thread (mm)	M40.5×P0.5
Size (mm)(∞)	Φ43×38.1
Weight(g)	73
Temperature Range	-10°C~+50°C

Model	LM8JCM-V	LM12JCM-V	LM16JCM-V	LM25JCM-V	LM35JCM-V	LM50JCM-V
Focal Length (mm)	8	12	16	25	35	50
Image Size (mm)	8.8×6.6 (Φ11)	8.8×6.6 (Φ11)	8.8×6.6 (Φ11)	8.8×6.6 (Φ11)	8.8×6.6 (Φ11)	8.8×6.6 (Φ11)
Iris Range (F-stop)	F1.4 / F4 / F8 / F16	F1.4 / F4 / F8 / F16	F1.4 / F4 / F8 / F16	F1.4 / F4 / F8 / F16	F2 / F4 / F8 / F16	F2.8 / F4 / F8 / F16
Focusing Range (m)	0.1~∞	0.15~∞	0.2~∞	0.2~∞	0.2~∞	0.2~∞
Control Iris	-	-	-	-	-	-
Focus	Manual	Manual	Manual	Manual	Manual	Manual
Shooting Range at M.O.D. (mm)	120.3(H)×90.0(V)	110.0(H)×82.5(V)	112.8(H)×84.4(V)	71.1(H)×53.3(V)	47.9(H)×35.8(V)	29.3(H)×21.9(V)
Angle of View (Degrees)	2/3 Inch: 56.5×43.9 1/1.8 Inch: 47.4×36.3 1/2 Inch: 42.6×32.5	38.3×29.1 31.7×24.0 28.3×21.4	30.0×22.7 24.7×18.6 21.8×16.4	19.6×14.8 16.1×12.1 14.0×10.5	14.4×10.8 11.8×8.8 10.5×7.9	9.6×7.2 7.9×5.9 7.0×5.2
Resolution(Center, Corner)	120lp/mm, 100lp/mm	120lp/mm, 100lp/mm	120lp/mm, 100lp/mm	120lp/mm, 100lp/mm	120lp/mm, 100lp/mm	120lp/mm, 100lp/mm
TV Distortion (%)	-0.6	-0.07	-0.05	-0.04	-0.2	-0.03
Back Focus in Air(mm)	9.74	11.7	13.1	11.7	20.1	35.5
Mount	C-mount	C-mount	C-mount	C-mount	C-mount	C-mount
Filter Thread (mm)	M27×P0.5	M27×P0.5	M27×P0.5	M27×P0.5	M27×P0.5	M27×P0.5
Size (mm)(∞)	Φ33.0×41.6	Φ33.0×37.0	Φ33.0×36.5	Φ33.0×39.5	Φ33.0×38.8	Φ33.0×56.2
Weight(g)	88	75	76.5	83	72.5	85
Temperature Range	-10°C~+50°C	-10°C~+50°C	-10°C~+50°C	-10°C~+50°C	-10°C~+50°C	-10°C~+50°C

† Images may differ from the actual product.

† Images may differ from the actual product.

JCM-WP Series

High Resolution FA/MV Lenses

The JCM-WP series is a water and dust resistant high-resolution lens with a design based on Kowa's ruggedized megapixel JCM-V lenses.

*Performance may not be secured depending on environment and condition to be used.

*Not intended for underwater use.

*Refer to the instructions and our web page for more information.

Features of JCM-WP Series

- ▶ Water repellency and easy cleaning of the front lens surface by applying Kowa's special coating.
- ▶ Two way reversible nut is utilized instead of thumb screws in order to tightly lock the focus adjustment ring in place.
- ▶ Utilizing two way reversible nut contributes to the prevention of screw dropping troubles.
- ▶ Interchangeable iris plates are used to select the F-stop.
- ▶ All internal glass elements are glued to the inside housing to improve stability.
- ▶ Equivalent to 2 megapixels performance

Interchangeable Iris Plates

- 1 The JCM-WP series uses interchangeable iris plates instead of mechanical iris diaphragms with moving blades. You can choose from four iris plates to adjust the F-stop.

Focus Adjustment Procedure

- 2 Unscrew the bottom ring of the outside body to adjust the focus to optimal position.
- 3 Screw the red two way reversible nut on the center body towards the bottom ring to lock in the focus.

Model	Format Size(Inch)								
	4/3	1.2	1.1	1	1/1.2	2/3	1/1.8	1/2	1/3
LM3NCM-WP	-	-	-	-	-	✓	✓	✓	✓
LM5JCM-WP	-	-	-	-	-	✓	✓	✓	✓
LM8JCM-WP	-	-	-	-	-	✓	✓	✓	✓
LM12JCM-WP	-	-	-	-	-	✓	✓	✓	✓
LM16JCM-WP	-	-	-	-	-	✓	✓	✓	✓
LM25JCM-WP	-	-	-	-	-	✓	✓	✓	✓
LM35JCM-WP	-	-	-	-	-	✓	✓	✓	✓
LM50JCM-WP	-	-	-	-	-	✓	✓	✓	✓



LM8JCM-WP



LM12JCM-WP



LM16JCM-WP



LM25JCM-WP



LM35JCM-WP



LM50JCM-WP



LM3NCM-WP NEW

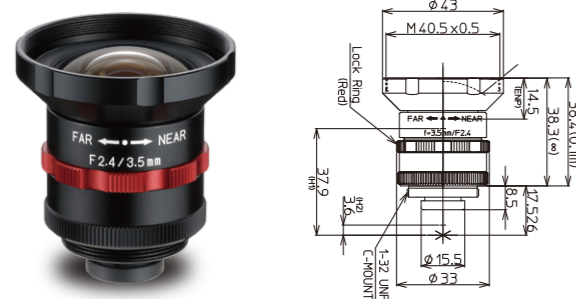

LM5JCM-WP

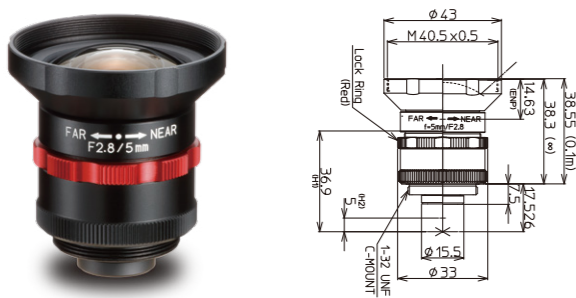

Interchangeable Iris Plates Two Way Reversible Nut

Model	LM3NCM-WP	LM5JCM-WP
Focal Length (mm)	3.5	5
Image Size (mm)	7.2x5.4 (Φ9)	8.8x6.6 (Φ11)
Iris Range (F-stop)	F2.8 / F4 / F5.6 / F8	F2.8 / F4 / F5.6 / F8
Focusing Range (m)	0.1~∞	0.1~∞
Control	Iris	Iris
Focus	Manual	Manual
Shooting Range at M.O.D. (mm)	226.3(H)x171.4(V)	200.8(H)x150.8(V)
Angle of View	2/3 Inch	82.4x66.9
(Degrees)	1/1.8 Inch	89.0x73.8
(Degrees)	1/2 Inch	82.4x66.9
Resolution(Center, Corner)	100lp/mm, 80lp/mm	120lp/mm, 100lp/mm
TV Distortion (%)	0.4	0.5
Back Focus in Air(mm)	10.0	10.2
Mount	C-mount	C-mount
Filter Thread (mm)	M40.5xP0.5	M40.5xP0.5
Size (mm)(∞)	Φ43x38.4	Φ43x38.3
Weight(g)	80	75
Temperature Range	-10°C~+50°C	-10°C~+50°C

† Images may differ from the actual product.

Model	LM8JCM-WP	LM12JCM-WP	LM16JCM-WP	LM25JCM-WP	LM35JCM-WP	LM50JCM-WP
Focal Length (mm)	8	12	16	25	35	50
Image Size (mm)	8.8x6.6 (Φ11)	8.8x6.6 (Φ11)	8.8x6.6 (Φ11)	8.8x6.6 (Φ11)	8.8x6.6 (Φ11)	8.8x6.6 (Φ11)
Iris Range (F-stop)	F1.4 / F4 / F8 / F16	F1.4 / F4 / F8 / F16	F1.4 / F4 / F8 / F16	F1.4 / F4 / F8 / F16	F2 / F4 / F8 / F16	F2.8 / F4 / F8 / F16
Focusing Range (m)	0.1~∞	0.15~∞	0.2~∞	0.2~∞	0.2~∞	0.2~∞
Control	Iris	Iris	Iris	Iris	Iris	Iris
Focus	Manual	Manual	Manual	Manual	Manual	Manual
Shooting Range at M.O.D. (mm)	120.3(H)x90.0(V)	110.0(H)x82.5(V)	112.8(H)x84.4(V)	71.1(H)x53.3(V)	47.9(H)x35.8(V)	29.3(H)x21.9(V)
Angle of View	56.5x43.9	38.3x29.1	30.0x22.7	19.6x14.8	14.4x10.8	9.6x7.2
(Degrees)	1/1.8 Inch	47.4x36.3	31.7x24.0	16.1x12.1	11.8x8.8	7.9x5.9
(Degrees)	1/2 Inch	42.6x32.5	28.3x21.4	14.0x10.5	10.5x7.9	7.0x5.2
Resolution(Center, Corner)	120lp/mm, 100lp/mm	120lp/mm, 100lp/mm	120lp/mm, 100lp/mm	120lp/mm, 100lp/mm	120lp/mm, 100lp/mm	120lp/mm, 100lp/mm
TV Distortion (%)	-0.6	-0.07	-0.05	-0.04	-0.2	-0.03
Back Focus in Air(mm)	9.74	11.7	13.1	11.7	19.9	35.4
Mount	C-mount	C-mount	C-mount	C-mount	C-mount	C-mount
Filter Thread (mm)	M27xP0.5	M27xP0.5	M27xP0.5	M27xP0.5	M27xP0.5	M27xP0.5
Size (mm)(∞)	Φ33.0x41.6	Φ33.0x36.5	Φ33.0x36.5	Φ33.0x39.7	Φ33.0x38.8	Φ33.0x56.2
Weight(g)	85	75	75	75	65	85
Temperature Range	-10°C~+50°C	-10°C~+50°C	-10°C~+50°C	-10°C~+50°C	-10°C~+50°C	-10°C~+50°C

† Images may differ from the actual product.

JC Series

- ▶ High resolution
- ▶ Low distortion
- ▶ Excellent cost performance
- ▶ Compact, lightweight and durable
- ▶ Excellent corner brightness

✓ Compatible ◇ Suitable — Incompatible

Model	Format Size(Inch)								
	4/3	1.2	1.1	1	1/1.2	2/3	1/1.8	1/2	1/3
LM6JC	-	-	-	✓	✓	✓	✓	✓	✓
LM8JC	-	-	-	-	✓	✓	✓	✓	✓
LM12JC	-	-	-	-	✓	✓	✓	✓	✓
LM16JC	-	-	-	-	✓	✓	✓	✓	✓
LM25JC	-	-	-	-	✓	✓	✓	✓	✓
LM35JC	-	-	-	◇	✓	✓	✓	✓	✓
LM50JC	-	-	◇	◇	✓	✓	✓	✓	✓

LM6JC

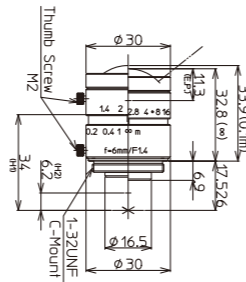

LM8JC

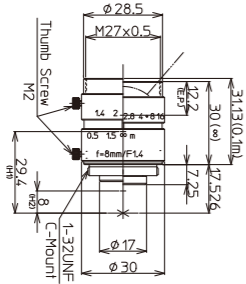

LM12JC

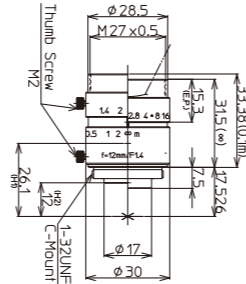

LM16JC

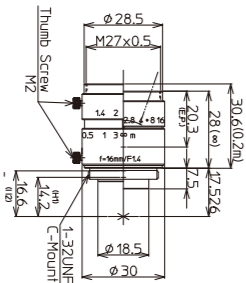

LM25JC

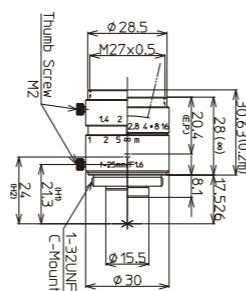

LM35JC

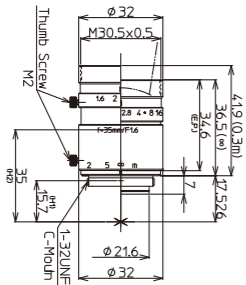

LM50JC

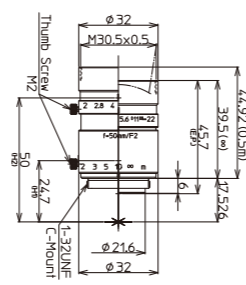

Model	LM6JC	LM8JC	LM12JC	LM16JC	LM25JC	LM35JC	LM50JC
Focal Length(mm)	6	8	12	16	25	35	50
Image Size(mm)	8.8×6.6(Φ11)	8.8×6.6(Φ11)	8.8×6.6(Φ11)	8.8×6.6(Φ11)	8.8×6.6(Φ11)	8.8×6.6(Φ11)	8.8×6.6(Φ11)
Iris Range(F-stop)	F1.4~F16	F1.4~F16	F1.4~F16	F1.4~F16	F1.6~F16	F1.6~F16	F2.0~F22
Focusing Range(m)	0.1~∞	0.1~∞	0.1~∞	0.2~∞	0.2~∞	0.3~∞	0.5~∞
Control	Iris Manual	Manual	Manual	Manual	Manual	Manual	Manual
Focus	Manual	Manual	Manual	Manual	Manual	Manual	Manual
Shooting Range at M.O.D.(mm)	190.6(H)×130.3(V)	136.0(H)×96.1(V)	81.1(H)×59.4(V)	111.8(H)×82.6(V)	72.1(H)×53.7(V)	76.0(H)×56.9(V)	85.0(H)×63.6(V)
Angle of View	2/3 Inch 81.9×61.2	64.2×47.7	42.5×31.7	30.5×22.8	21.0×15.7	14.4×10.8	10.1×7.6
View (Degrees)	1/1.8 Inch 66.9×50.1	52.4×39.1	34.6×25.9	23.8×18.7	17.2×12.9	11.8×8.8	8.2×6.2
Resolution(Center, Corner)	100lp/mm, 60lp/mm	100lp/mm, 60lp/mm	100lp/mm, 60lp/mm	100lp/mm, 60lp/mm	100lp/mm, 60lp/mm	100lp/mm, 60lp/mm	100lp/mm, 60lp/mm
TV Distortion(%)	-10.7	-6.2	-2.5	-1.5	-0.6	-0.2	-0.1
Back Focus in Air(mm)	11.3	11.3	11.1	12.1	10.3	14.9	17.2
Mount	C-mount	C-mount	C-mount	C-mount	C-mount	C-mount	C-mount
Filter Thread(mm)	-	M27×P0.5	M27×P0.5	M27×P0.5	M27×P0.5	M30.5×P0.5	M30.5×P0.5
Size(mm)(∞)	Φ30×32.8	Φ30×30	Φ30×31.5	Φ30×28	Φ30×28	Φ32×36.5	Φ32×39.5
Weight(g)	65	60	60	55	55	85	90
Temperature Range	-10°C~+50°C	-10°C~+50°C	-10°C~+50°C	-10°C~+50°C	-10°C~+50°C	-10°C~+50°C	-10°C~+50°C

Diagram of M.O.D. / Magnification Using A Close Up Ring

Model	LM6JC	LM8JC	LM12JC	LM16JC	LM25JC	LM35JC	LM50JC
(Non)M.O.D./Magnification	100mm/0.06x	100mm/0.07x	100mm/0.12x	200mm/0.08x	200mm/0.12x	300mm/0.12x	500mm/0.10x
(1mm Ring)M.O.D./Magnification	-	-	50mm/0.19x	110mm/0.14x	136mm/0.15x	240mm/0.14x	422mm/0.12x
(5mm Ring)M.O.D./Magnification	-	-	-	-	46mm/0.31x	132mm/0.26x	264mm/0.20x
(10mm Ring)M.O.D./Magnification	-	-	-	-	-	84mm/0.40x	183mm/0.30x
(20mm Ring)M.O.D./Magnification	-	-	-	-	-	-	117mm/0.50x

1/1.8" STANDARD

NCL Series

- ▶ 4 wide angle lenses
- ▶ Locking screws
- ▶ Metal body

LM4NCL

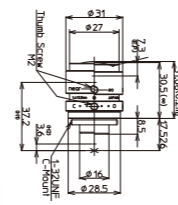

LM5NCL

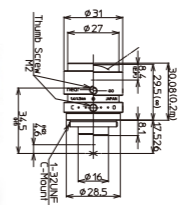

LM6NCL

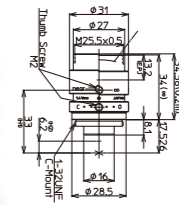

LM12NCL

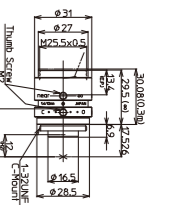

Model	LM4NCL	LM5NCL	LM6NCL	LM12NCL
Focal Length(mm)	3.5	4.5	6	12
Image Size(mm)	7.2×5.4(Φ9)	7.2×5.4(Φ9)	7.2×5.4(Φ9)	7.2×5.4(Φ9)
Iris Range(F-stop)	F1.4~F16	F1.4~F16	F1.4~F16	F1.4~F16
Focusing Range(m)	0.2~∞	0.2~∞	0.2~∞	0.3~∞
Control	Iris Manual	Manual	Manual	Manual
Focus	Manual	Manual	Manual	Manual
Shooting Range at M.O.D.(mm)	679.9(H)×389.3(V)	405.3(H)×273.8(V)	255.8(H)×188.7(V)	189.9(H)×140.0(V)
Angle of View	1/1.8 inch 117.7×86.7	88.8×66.9	62.7×48.4	34.6×25.9
View (Degrees)	1/2 inch 103.6×76.7	79.0×59.4	57.3×44.0	30.7×23.0
Resolution(Center, Corner)	100lp/mm, 60lp/mm	100lp/mm, 60lp/mm	100lp/mm, 60lp/mm	100lp/mm, 60lp/mm
TV Distortion(%)	-28.0	-17.5	-1.0	-0.8
Back Focus in Air(mm)	8.9	10.0	9.5	11.1
Mount	C-mount	C-mount	C-mount	C-mount
Filter Thread(mm)	-	-	M25.5×P0.5	M25.5×P0.5
Size(mm)(∞)	Φ31×30.5	Φ31×29.5	Φ31×34	Φ31×29.5
Weight(g)	60	55	60	55
Temperature Range	-10°C~+50°C	-10°C~+50°C	-10°C~+50°C	-10°C~+50°C

✓ Compatible ◇ Suitable — Incompatible

Model	Format Size(Inch)								
	4/3	1.2	1.1	1	1/1.2	2/3	1/1.8	1/2	1/3
LM4NCL	-	-	-	✓	✓	✓	✓	✓	✓
LM5NCL	-	-	-	-	✓	✓	✓	✓	✓
LM6NCL	-	-	-	-	✓	✓	✓	✓	✓
LM12NCL	-	-	-	◇	✓	✓	✓	✓	✓

Diagram of M.O.D. / Magnification Using A Close Up Ring

Model	LM4NCL	LM5NCL	LM6NCL	LM12NCL
(Non)M.O.D./Magnification	200mm/0.018x	200mm/0.02x	200mm/0.03x	300mm/0.08x
(1mm Ring)M.O.D./Magnification	-	-	22mm/0.19x	93mm/0.12x
(5mm Ring)M.O.D./Magnification	-	-	-	22mm/0.45x

† Images may differ from the actual product.

† Images may differ from the actual product.

HC-VIS-SW Series NEW

Features of HC-VIS-SW Series

- ▶ A maximum of 12 megapixel and 3.1 μ m performance can be found at select wavelength ranges.
- ▶ Virtually zero focus shift from visible to 2000nm wavelength range.
- ▶ Utilizes ultra wideband multi-coatings to increase transmission.
- ▶ Special extra low dispersion (XD) glass significantly reduces chromatic aberration, otherwise known as color fringing.
- ▶ Focal length 8mm, 16mm and 35mm : To Be Released in 2021

Model	Format Size(Inch)					
	4/3	1.2	1.1	1	1/1.2	2/3
LM12HC-VIS-SW	✓	✓	✓	✓	✓	✓
LM25HC-VIS-SW	✓	✓	✓	✓	✓	✓
LM50HC-VIS-SW	◇	◇	◇	✓	✓	✓

✓ Compatible ◇ Suitable — Incompatible

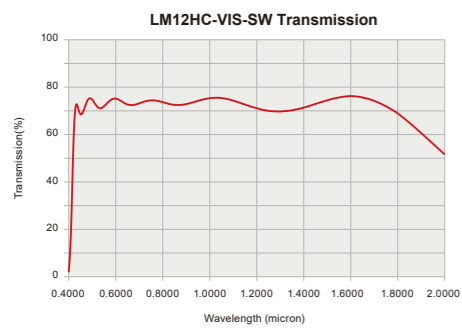

Design of IR-Corrected Lenses

In addition to having high transmission, Kowa's HC-VIS-SW series is IR-Corrected. The primary benefit for IR-Correction is that it allows an image to remain in focus even when the wavelength changes from visible to infrared or vice versa. With a standard visible, NIR or SWIR lens, a focus shift will occur due to differences in the refractive index if the wavelength fluctuates. However, by incorporating extra low dispersion (XD) glass and carefully aligning all internal lens elements, such focus shift problems are eliminated.

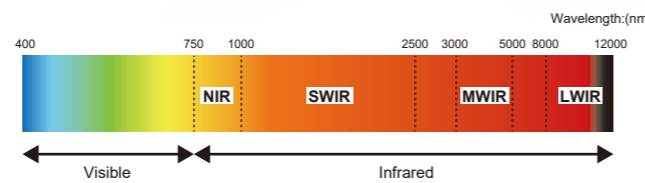

Example of Focus Shift

* Focusing at 1650nm

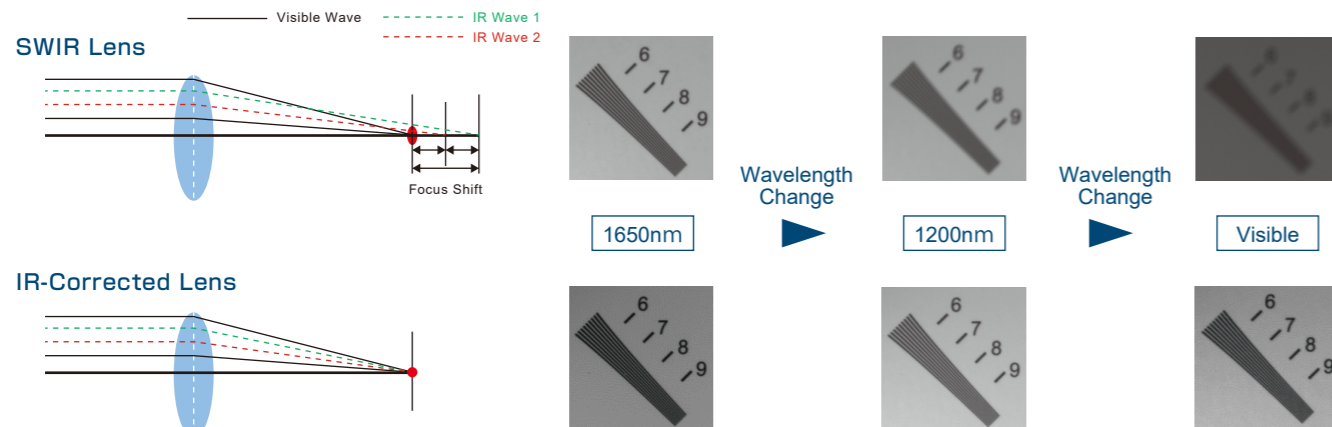

NEW LM12HC-VIS-SW



NEW LM25HC-VIS-SW



NEW LM50HC-VIS-SW



Model	LM12HC-VIS-SW
Focal Length(mm)	12
Image Size(mm)	12.8 × 9.6 (Φ16)
Iris Range(F-stop)	F1.8-F16
Focusing Range(m)	0.2-∞
Control	Manual
Focus	Manual
Shooting Range at M.O.D.(mm)	237.0(H)×175.0(V)
Angle of View	1 Inch: 58.0×44.5
View (Degrees)	2/3 Inch: 41.0×31.1
	1/1.8 Inch: 33.8×25.5
Resolution(Center, Corner)	160lp/mm, 100lp/mm
TV Distortion(%)	-1.6
Back Focus in Air(mm)	11.1
Mount	C-mount
Filter Thread(mm)	M34×P0.5
Size(mm)(∞)	Φ38×73.5
Weight(g)	175
Temperature Range	-10°C~+50°C

Model	LM25HC-VIS-SW
Focal Length(mm)	25
Image Size(mm)	12.8 × 9.6 (Φ16)
Iris Range(F-stop)	F1.8-F16
Focusing Range(m)	0.2-∞
Control	Manual
Focus	Manual
Shooting Range at M.O.D.(mm)	109.0(H)×81.0(V)
Angle of View	1 Inch: 29.2×22.0
View (Degrees)	2/3 Inch: 20.2×15.0
	1/1.8 Inch: 16.5×12.3
Resolution(Center, Corner)	160lp/mm, 100lp/mm
TV Distortion(%)	-0.97
Back Focus in Air(mm)	24.5
Mount	C-mount
Filter Thread(mm)	M27×P0.5
Size(mm)(∞)	Φ39×65.5
Weight(g)	160
Temperature Range	-10°C~+50°C

Model	LM50HC-VIS-SW
Focal Length(mm)	50
Image Size(mm)	12.8 × 9.6 (Φ16)
Iris Range(F-stop)	F2.5-F16
Focusing Range(m)	0.5-∞
Control	Manual
Focus	Manual
Shooting Range at M.O.D.(mm)	127.0(H)×95.0(V)
Angle of View	1 Inch: 14.6×11.0
View (Degrees)	2/3 Inch: 10.0×7.6
	1/1.8 Inch: 8.2×6.2
Resolution(Center, Corner)	160lp/mm, 100lp/mm
TV Distortion(%)	-0.11
Back Focus in Air(mm)	34.9
Mount	C-mount
Filter Thread(mm)	M30.5×P0.5
Size(mm)(∞)	Φ39.5×71
Weight(g)	155
Temperature Range	-10°C~+50°C

Diagram of M.O.D. / Magnification Using A Close Up Ring

Model	LM12HC-VIS-SW	LM25HC-VIS-SW	LM50HC-VIS-SW
(Non)M.O.D./Magnification	200mm/0.0562×	200mm/0.120×	500mm/0.101×
(1mm Ring)M.O.D./Magnification	73mm/0.139×	147mm/0.159×	418mm/0.121×
(5mm Ring)M.O.D./Magnification	12mm/0.485×	68mm/0.316×	252mm/0.200×
(10mm Ring)M.O.D./Magnification	-	37mm/0.514×	168mm/0.301×
(20mm Ring)M.O.D./Magnification	-	16mm/0.895×	102mm/0.497×

JC5M-IR Series

- ▶ 5 megapixel lens
- ▶ IR corrected design
- ▶ Fast F-stop of F1.4 *LM35JC5M-IR is F2.0
- ▶ Low distortion

✓ Compatible ◇ Suitable ✗ Incompatible

Model	Format Size(Inch)						
	4/3	1.2	1.1	1	1/1.2	2/3	1/1.8
LM16JC5M-IR	✓	✓	✓	✓	✓	✓	✓
LM25JC5M-IR	✓	✓	✓	◇	✓	✓	✓
LM35JC5M-IR	✓	✓	✓	◇	✓	✓	✓

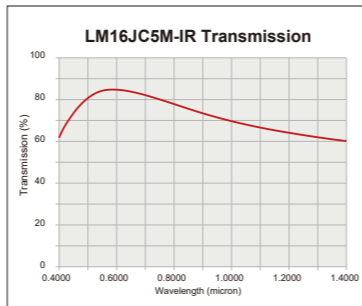

LM16JC5M-IR



LM25JC5M-IR



LM35JC5M-IR



Model	LM16JC5M-IR	LM25JC5M-IR	LM35JC5M-IR
Focal Length(mm)	16	25	35
Image Size(mm)	8.8×6.6(Φ11)	8.8×6.6(Φ11)	8.8×6.6(Φ11)
Iris Range(F-stop)	F1.4~F16	F1.4~F16	F2.0~F22
Focusing Range(m)	0.3~∞	0.3~∞	0.3~∞
Control	Iris: Manual Focus: Manual	Iris: Manual Focus: Manual	Iris: Manual Focus: Manual
Shooting Range at M.O.D.(mm)	171.4(H)×127.4(V)	113.3(H)×84.5(V)	75.8(H)×56.6(V)
Angle of View	2/3 Inch: 30.9×23.2 1/1.8 Inch: 25.4×19.0 1/2 Inch: 22.6×16.9	2/3 Inch: 20.1×15.1 1/1.8 Inch: 16.5×12.4 1/2 Inch: 14.6×11.0	2/3 Inch: 13.9×10.5 1/1.8 Inch: 11.4×8.3 1/2 Inch: 10.2×7.6
Resolution(Center, Corner)	120lp/mm, 80lp/mm	120lp/mm, 80lp/mm	120lp/mm, 80lp/mm
TV Distortion(%)	-0.8	-0.3	-0.3
Back Focus in Air(mm)	14.7	12	19.2
Mount	C-mount	C-mount	C-mount
Filter Thread(mm)	M27×P0.5	M30.5×P0.5	M30.5×P0.5
Size(mm)(∞)	Φ34.0×44.5	Φ34.0×47.0	Φ34.0×43.0
Weight(g)	100	110	100
Temperature Range	-10°C~+50°C	-10°C~+50°C	-10°C~+50°C

HC-SW Series

- ▶ Incorporating Kowa's special coating technology, the 1" format HC-SW series will maintains high transmission from 800nm to 1900nm.
- ▶ Designed for Near Infrared(NIR) and Short Wavelength Infrared (SWIR) applications.

✓ Compatible ◇ Suitable ✗ Incompatible

Model	Format Size(Inch)						
	4/3	1.2	1.1	1	1/1.2	2/3	1/1.8
LM8HC-SW	✓	✓	✓	✓	✓	✓	✓
LM12HC-SW	✓	✓	✓	✓	✓	✓	✓
LM16HC-SW	✓	✓	✓	✓	✓	✓	✓
LM25HC-SW	✓	✓	✓	✓	✓	✓	✓
LM35HC-SW	✓	✓	✓	✓	✓	✓	✓
LM50HC-SW	✓	✓	✓	✓	✓	✓	✓

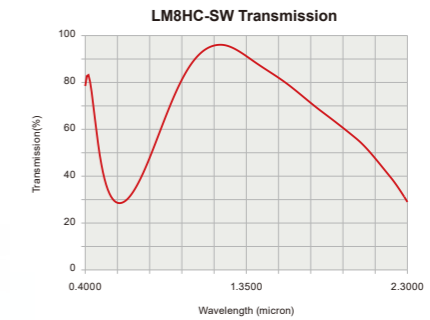

LM8HC-SW



LM12HC-SW



LM16HC-SW



LM25HC-SW



LM35HC-SW



LM50HC-SW



Reduction of visible-NIR focus shift

Visible design lens



Visible



Wavelength Change



NIR Focus Shift

IR Corrected design lens

Kowa's IR-lens



Visible



Wavelength Change



NIR Maintains sharp Focus

Examples



Visible



Wavelength Change

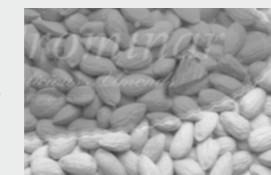

NIR



Visible



Wavelength Change



NIR

† Images may differ from the actual product.

Model	LM8HC-SW	LM12HC-SW	LM16HC-SW	LM25HC-SW	LM35HC-SW	LM50HC-SW
Focal Length(mm)	8	12.5	16	25	35	50
Image Size(mm)	12.8×9.6(Φ16)	12.8×9.6(Φ16)	12.8×9.6(Φ16)	12.8×9.6(Φ16)	12.8×9.6(Φ16)	12.8×9.6(Φ16)
Iris Range(F-stop)	F1.4~F16	F1.4~F16	F1.4~F16	F1.4~F16	F1.4~F16	F1.4~F16
Focusing Range(m)	0.1~∞	0.3~∞	0.3~∞	0.3~∞	0.3~∞	0.5~∞
Control	Iris: Manual Focus: Manual	Iris: Manual Focus: Manual	Iris: Manual Focus: Manual	Iris: Manual Focus: Manual	Iris: Manual Focus: Manual	Iris: Manual Focus: Manual
Shooting Range at M.O.D.(mm)	196.0(H)×143.2(V)	330.6(H)×243.5(V)	251.5(H)×186.2(V)	160.7(H)×119.2(V)	110.1(H)×82.0(V)	121.8(H)×91.3(V)
Angle of View	1 inch: 79.4×63.0 2/3 inch: 58.3×44.7 1/1.8 inch: 48.5×36.9	1 inch: 55.6×42.5 2/3 inch: 39.1×29.5 1/1.8 inch: 32.1×24.2	1 inch: 44.3×33.6 2/3 inch: 30.8×23.2 1/1.8 inch: 25.3×19.0	1 inch: 29.3×22.0 2/3 inch: 20.2×15.1 1/1.8 inch: 16.5×12.4	1 inch: 20.9×15.8 2/3 inch: 14.4×10.8 1/1.8 inch: 11.8×8.8	1 inch: 14.5×10.8 2/3 inch: 10.0×7.5 1/1.8 inch: 8.2×6.2
Resolution(Center, Corner)	120lp/mm, 80lp/mm	120lp/mm, 80lp/mm	120lp/mm, 80lp/mm	120lp/mm, 80lp/mm	120lp/mm, 80lp/mm	120lp/mm, 80lp/mm
TV Distortion(%)	-1.2	-1.58	-1.0	-1.0	-0.5	0.05
Back Focus in Air(mm)	11.2	12.6	12.6	16.5	16.8	14.8
Mount	C-mount	C-mount	C-mount	C-mount	C-mount	C-mount
Filter Thread(mm)	M55×P0.75	M35.5×P0.5	M35.5×P0.5	M35.5×P0.5	M35.5×P0.5	M40.5×P0.5
Size(mm)(∞)	Φ57×58	Φ43×51.5	Φ43×52.9	Φ43×43	Φ43×43	Φ49×48
Weight(g)	205	160	150	135	135	210
Temperature Range	-10°C~+50°C	-10°C~+50°C	-10°C~+50°C	-10°C~+50°C	-10°C~+50°C	-10°C~+50°C

† Images may differ from the actual product.

LINE SCAN $\Phi 46.0\text{mm}$ IMAGE SIZE $\Phi 30.0\text{mm}$ IMAGE SIZE (3CMOS)

LF Series

- ▶ Large format (Image size $\Phi 46.0\text{mm}$)
- ▶ Corresponds to 4K Line Scan Camera
- ▶ Low distortion
- ▶ Suitable for close distance inspection

Optimized design for machine vision

LM28LF

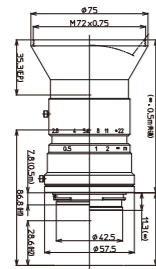

LM35LF

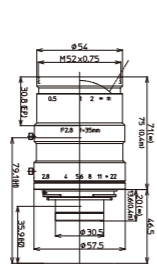

LM50LF

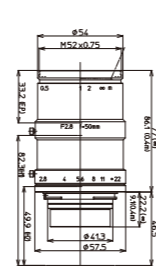

✓ Compatible ◊ Suitable - Incompatible

Model	Format Size(Φ)								
	57.0	51.0	46.0	38.0	35.0	30.0	28.0	23.0	18.0
LM28LF	-	-	✓	✓	✓	✓	✓	✓	✓
LM35LF	-	◊	✓	✓	✓	✓	✓	✓	✓
LM50LF	-	◊	✓	✓	✓	✓	✓	✓	✓

Model	LM28LF	LM28LF-48	LM35LF	LM35LF-48	LM50LF	LM50LF-48
Focal Length(mm)	28		35		50	
Image Size(mm)	46.0(Φ46)		46.0(Φ46)		46.0(Φ46)	
Iris Range(F-stop)	F2.8~F22		F2.8~F22		F2.8~F22	
Focusing Range(m) (FROM SENSOR)	0.5~∞		0.4~∞		0.4~∞	
Control	Iris Manual		Iris Manual		Iris Manual	
	Focus Manual		Focus Manual		Focus Manual	
Shooting Range at M.O.D.(mm)	424.3×281.1		239.9×160.3		162.9×108.9	
Angle of View	Full size 64.6×45.8		Full size 53.7×37.2		Full size 39.7×27.1	
View	4/3 inch 35.8×27.2		4/3 inch 28.9×21.8		4/3 inch 20.9×15.7	
(Degrees)	1 inch 25.3×19.1		1 inch 20.3×15.3		1 inch 14.6×11.0	
Resolution(Center, Corner)	160lp/mm, 63lp/mm		160lp/mm, 63lp/mm		160lp/mm, 63lp/mm	
TV Distortion(%)	-0.17		-0.15		-0.04	
Flange Back in Air(mm)	46.5	17.5	46.5	17.5	46.5	17.5
Mount	Nikon F-mount	TFL-II mount	Nikon F-mount	TFL-II mount	Nikon F-mount	TFL-II mount
Filter Thread(mm)	M72×P0.75		M52×P0.75		M52×P0.75	
Size(mm)(∞)	Φ75×98	Φ75×127	Φ57.5×71	Φ57.5×100	Φ57.5×77	Φ57.5×106
Weight(g)	500		430		470	

Nikon is a trademark of Nikon Corporation.

- ▶ For industrial 3CMOS color line scan camera
- ▶ Ultra high resolution ▶ For use with 30mm length line sensor
- ▶ Low chromatic aberration ▶ Excellent corner brightness
- ▶ Close up lens is available for close distance applications

CLS Series

LM28CLS

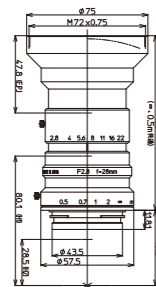

LM35CLS

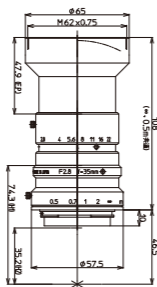

LM50CLS

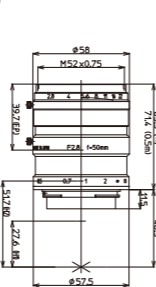

✓ Compatible ◊ Suitable - Incompatible

Model	Format Size(Φ)								
	57.0	51.0	46.0	38.0	35.0	30.0	28.0	23.0	18.0
LM28CLS	-	-	-	-	-	✓	✓	✓	✓
LM35CLS	-	-	-	-	-	✓	✓	✓	✓
LM50CLS	-	-	-	-	◊	✓	✓	✓	✓

Model	LM28CLS	LM35CLS	LM50CLS
Focal Length(mm)	28		
Image Size(mm)	30.0(Φ30)	30.0(Φ30)	30.0(Φ30)
Iris Range(F-stop)	F2.8~F22	F2.8~F22	F2.8~F22
Focusing Range(m) (FROM SENSOR)	0.5~∞	0.5~∞	0.5~∞
Control	Iris Manual	Iris Manual	Iris Manual
	Focus Manual	Focus Manual	Focus Manual
Shooting Range at M.O.D.(mm)	317.9(V)	259.1(V)	157.7(V)
Angle of View(Degrees)	55.2(V)	46.1(V)	32.3(V)
Resolution(Center, Corner)	160lp/mm, 63lp/mm	160lp/mm, 63lp/mm	160lp/mm, 63lp/mm
TV Distortion(%)	-0.1	0.06	-0.1
Flange Back in Air(mm)	46.5	46.5	46.5
Mount	Nikon F-mount	Nikon F-mount	Nikon F-mount
Filter Thread(mm)	M72×P0.75	M62×P0.75	M52×P0.75
Size(mm)(∞)	Φ75×108	Φ65×108	Φ58×63.5
Weight(g)	482	480	358

Nikon is a trademark of Nikon Corporation.
† Images may differ from the actual product.

1/2.5" MEGAPIXEL S-MOUNT LENS (3.2μm)

- ▶ Low distortion ▶ Wide optical design ▶ High transmission from VIS to NIR

LM3QS28 / 40 / 56

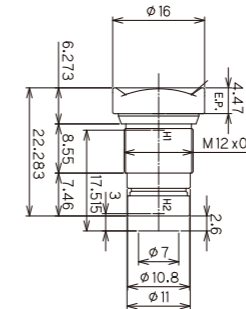

✓ Compatible ◊ Suitable - Incompatible

Model	Format Size(Inch)								
	1.1	1	1/1.2	2/3	1/1.8	1/2	1/2.5	1/2.8	1/3
LM3QS28	-	-	-	-	-	✓	-	-	-
LM3QS40	-	-	-	-	-	✓	-	-	-
LM3QS56	-	-	-	-	-	✓	-	-	-

Model	LM3QS28	LM3QS40	LM3QS56
Focal Length(mm)	3		
Image Size	1/2.5		
Iris Range(F-stop)	F2.8	F4	F5.6
Focusing Range(m)	0.1~∞		
Angle of View	1/2.5 inch 86.7×70.6	1/2.8 inch 83.3×58.2	1/3 inch 76.9×61.6
Resolution(Center, Corner)	160lp/mm, 125lp/mm		
TV Distortion(%)	0.02		
Back Focus in Air(mm)	2.6		
Mount	S-mount (M12×0.5)		
Size(mm)(∞)	Φ16×22.3		
Weight(g)	6		
Temperature Range	-10°C~+50°C		

1/3" NF-MOUNT

Compact NF-mt. lens Series

- ▶ Introducing the lineup of megapixel NF-mount lenses. The compact body and high resolution design will maximize the performance of NF-mount camera.

✓ Compatible ◊ Suitable - Incompatible

Model	Format Size(Inch)								
	4/3	1.2	1.1	1	1/1.2	2/3	1/1.8	1/2	1/3
LM3NF	-	-	-	-	-	-	-	-	✓
LM5NF	-	-	-	-	-	-	-	-	✓
LM9NF	-	-	-	-	-	-	-	◊	✓

LM3NF

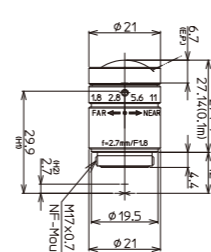

LM5NF

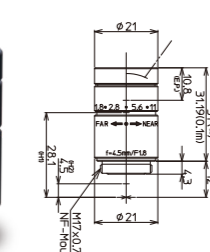

LM9NF

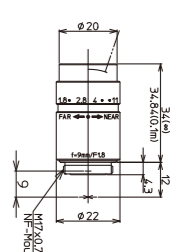

Model	LM3NF	LM5NF	LM9NF
Focal Length(mm)	2.7	4.5	9
Image Size(mm)	4.8×3.6(Φ6)	4.8×3.6(Φ6)	4.8×3.6(Φ6)
Iris Range(F-stop)	F1.8~F11	F1.8~F11	F1.8~F11
Focusing Range(m)	0.1~∞	0.1~∞	0.1~∞
Control	Iris Manual	Iris Manual	Iris Manual
	Focus Manual	Focus Manual	Focus Manual
Shooting Range at M.O.D.(mm)	262.7(H)×167.8(V)	122.9(H)×89.9(V)	58.1(H)×43.3(V)
Angle of View(Degrees) 1/3 Inch	102.3×76.7	59.2×45.0	30.2×22.8
Resolution(Center, Corner)	100lp/mm, 60lp/mm	100lp/mm, 60lp/mm	100lp/mm, 60lp/mm
TV Distortion(%)	-7.3	-2.8	-0.6
Back Focus in Air(mm)	7.8	8.1	8.6
Mount	NF-mount	NF-mount	NF-mount
Size(mm)(∞)	Φ21×27	Φ21×31	Φ22×34
Weight(g)	30	35	40
Temperature Range	-10°C~+50°C		

† Images may differ from the actual product.

TELECENTRIC Series

High Resolution Lenses

Features of TC Series

- ▶ Produces high contrast and resolution in both the center and corners.
- ▶ Virtually no TV distortion of entire image area.

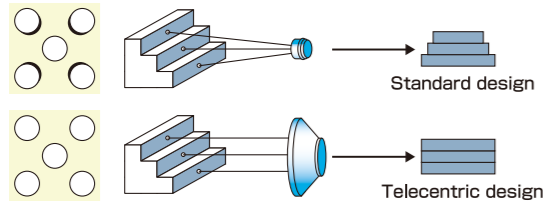

Telecentric Optical System

In a telecentric optical system, there is no change in magnification when focusing. Thus, the magnification remains constant at different working distances. Similarly, the movement of an object also does not change the magnification, which makes a telecentric lens ideal for measuring objects with high accuracy.

In a telecentric optical system, the chief rays are parallel to the optical axis. As a result, the aperture becomes greater as the magnification is fixed by the focusing rays. This means that the F-number on a telecentric lens tends to be larger when compared to a standard megapixel lens.

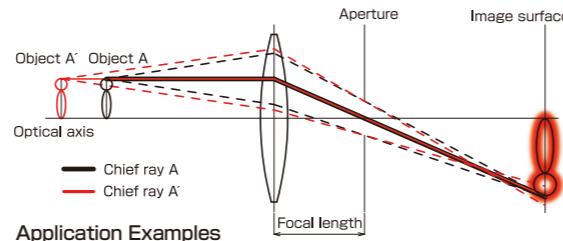

Application Examples

- ▶ Surface inspection of silicon wafers
- ▶ Image defect inspections
- ▶ Inspection of dirt on prisms and glass circuit boards
- ▶ Measurement of thread pitches
- ▶ Reading 2D codes

Model	Format Size(Inch)								
	4/3	1.2	1.1	1	1/1.2	2/3	1/1.8	1/2	1/3
LM1119TC	✓	✓	✓	✓	✓	✓	✓	✓	✓
LM1138TC	✓	✓	✓	✓	✓	✓	✓	✓	✓
LM1120TC	✓	✓	✓	✓	✓	✓	✓	✓	✓
LM1121TC	✓	✓	✓	✓	✓	✓	✓	✓	✓
LM1122TC	✓	✓	✓	✓	✓	✓	✓	✓	✓
LM1123TC	✓	✓	✓	✓	✓	✓	✓	✓	✓
LM1125TC	✓	✓	✓	✓	✓	✓	✓	✓	✓

2/3" TELECENTRIC 5 MEGAPIXEL PLUS

- ▶ Telecentric lens with variable magnification
- ▶ Able to adjust the magnification to match with the pixel size of the camera
- ▶ Lenses are designed with an optical magnification that is ideal for over 5 megapixels
- ▶ Distortion free lenses of less than 0.02%. TV distortion is limited to 0.25% on the entire image area even when used with a 5 megapixel camera

LM1120TC



LM1121TC



LM1122TC



LM1123TC

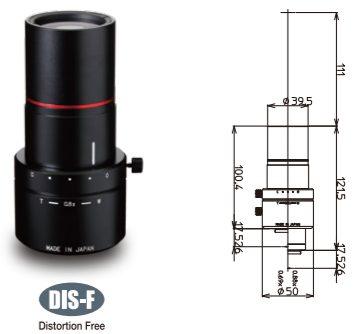

LM1125TC



4/3" MACRO ZOOM 21 MEGAPIXEL

- ▶ Telecentric lens with variable magnification
- ▶ Able to resolve up to 21 megapixels
- ▶ 0.5x~1.0x for macro use

LM1119TC

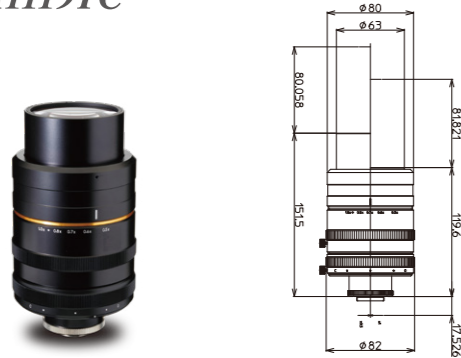

4/3" MACRO 21 MEGAPIXEL

- ▶ 2.0x for macro use
- ▶ Able to resolve up to 21 megapixels

LM1138TC



Model	LM1119TC		LM1138TC
Magnification Range	0.5~1.0x		2.0x
Image Size	18.4x13.8(Φ23)		18.4x13.8(Φ23)
Shooting Magnification	0.5x	1.0x	2.0x
Objective N.A.	0.05	0.1	0.2
W.D(mm)	80	81.8	80.6
Shooting Range (mm)	4/3 inch	36.8x27.6	18.4x13.8
	1 inch	25.6x19.2	12.8x9.6
	2/3 inch	17.6x13.2	8.8x6.6
TV Distortion(%)	0.1	0.1	0.1
Back Focus in Air(mm)	14.7		15.0
Mount	C-mount		C-mount
Resolution	120lp/mm		120lp/mm
Size(mm)(∞)	Φ82x151.5		Φ64x151.0
Weight(g)	1000		830
Temperature Range	-10°C~+50°C		-10°C~+50°C
Storage Temperature Range	-20°C~+60°C		-20°C~+60°C

† Images may differ from the actual product.

Model	LM1120TC			LM1121TC			LM1122TC			LM1123TC			LM1125TC			
Magnification Range	3.45~4.4x			1.725~2.2x			1.15~1.47x			0.69~0.88x			0.346~0.44x			
Image Size	8.8x6.6(Φ11)			8.8x6.6(Φ11)			8.8x6.6(Φ11)			8.8x6.6(Φ11)			8.8x6.6(Φ11)			
Shooting Magnification	3.45x	4.0x	4.4x	1.725x	2.0x	2.2x	1.15x	1.3x	1.47x	0.69x	0.8x	0.88x	0.346x	0.4x	0.44x	
Objective N.A.	0.2	0.2	0.2	0.131	0.131	0.131	0.101	0.101	0.101	0.07	0.07	0.07	0.04	0.04	0.04	
W.D(mm)	65.9	65.9	65.9	114.8	111.4	109.4	111.6	111.6	111.6	111.0	111.0	111.0	112.7	112.7	112.7	
Shooting Range (mm)	2/3 inch	2.6x1.9	2.2x1.7	2.0x1.5	5.1x3.8	4.4x3.3	4.0x3.0	7.6x5.7	6.6x5.0	6.0x4.5	12.7x9.6	11.0x8.2	10.0x7.5	25.4x19.1	22.0x16.5	20.0x15.0
	1/1.8 inch	2.1x1.6	1.8x1.4	1.6x1.2	4.2x3.1	3.6x2.7	3.3x2.4	6.3x4.7	5.5x4.1	4.9x3.7	10.4x7.8	9.0x6.7	8.2x6.1	20.9x15.7	18.1x13.6	16.5x12.3
	1/2 inch	1.9x1.4	1.6x1.2	1.5x1.1	3.7x2.8	3.2x2.4	2.9x2.2	5.6x4.2	4.9x3.7	4.3x3.3	9.3x7.0	8.0x6.0	7.3x5.5	18.6x13.9	16.1x12.1	14.6x11.0
TV Distortion(%)	0.015	0.003	-0.002	0.011	0.004	0.001	-0.015	-0.001	0.011	-0.001	-0.009	0.005	0.02	-0.009	0.01	
Back Focus in Air(mm)	17.1	24.5	30	55.8	67.7	76.3	18.7	23.6	29.8	34	28.8	25.3	17.6	17	16.5	
Mount	C-mount			C-mount			C-mount			C-mount			C-mount			
Resolution	120lp/mm			120lp/mm			120lp/mm			120lp/mm			120lp/mm			
Filter Thread(mm)	-			-			-			-			-			
Size(mm)(∞)	Φ57x180.0			Φ48x147.5			Φ50x123.9			Φ50x121.5			Φ51.5x142.3			
Weight(g)	645			420			330			290			420			
Temperature Range	-10°C~+50°C			-10°C~+50°C			-10°C~+50°C			-10°C~+50°C			-10°C~+50°C			
Storage Temperature Range	-20°C~+60°C			-20°C~+60°C			-20°C~+60°C			-20°C~+60°C			-20°C~+60°C			

† Images may differ from the actual product.

LMVZ4411



LO-DIS
Low Distortion

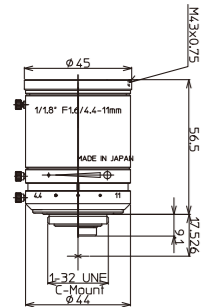

Model	LMVZ4411
Focal Length(mm)	4.4~11(2.5x)
Image Size(mm)	7.2x5.4(Φ9)
Iris Range(F-stop)	F1.6~F16
Focusing Range(m)	0.3~∞
Control	Manual
Focus	Manual
Shooting Range at M.O.D.(mm)	W507.5x379.0/T211.4x159.0
Angle of View	1/1.8 Inch W76.6x61.2/T36.7x28.0
View	1/2 Inch W70.2x55.5/T32.9x25.0
(Degrees)	1/3 Inch W55.5x43.0/T25.0x18.9
TV Distortion(%)	W-0.2/T0.4
Back Focus in Air(mm)	W8.8/T14.5
Mount	C-mount
Filter Thread(mm)	M43xP0.75
Size(mm)(∞)	Φ45x56.5
Weight(g)	125
Temperature Range	-10°C~+50°C

LMVZ990-IR



LO-DIS
Low Distortion

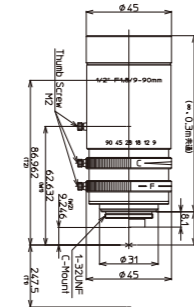

Model	LMVZ990-IR
Focal Length(mm)	9~90(10x)
Image Size(mm)	6.4x4.8(Φ8)
Iris Range(F-stop)	F1.8~F16
Focusing Range(m)	0.3~∞
Control	Manual
Focus	Manual
Shooting Range at M.O.D.(mm)	W252.7x182.5/T94.4x70.8
Angle of View	1/2 Inch W41.1x30.3/T4.2x3.1
(Degrees)	1/3 Inch W30.3x22.5/T3.1x2.4
TV Distortion(%)	W-4.3/T0.3
Back Focus in Air(mm)	W15.4/T11.7
Mount	C-mount
Filter Thread(mm)	M43xP0.75
Size(mm)(∞)	Φ45x93
Weight(g)	194
Temperature Range	-10°C~+50°C

✓ Compatible ◇ Suitable - Incompatible

Model	Format Size(Inch)								
	4/3	1.2	1.1	1	1/1.2	2/3	1/1.8	1/2	1/3
LMVZ4411	-	-	-	-	-	-	✓	✓	✓
LMVZ990-IR	-	-	-	-	-	-	-	-	✓

MACRO ZOOM

▶ Excellent for pattern matching, measurement, inspection, and character recognition

LMZ45T3

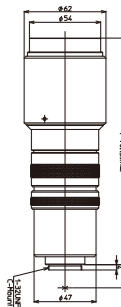

Model	LMZ45T3			
Magnification	inf~1.1x			
Zoom Magnification	6x			
Image Size(mm)	8.8x6.6(Φ11)			
Close up lens	3Dpt.un-installed		3Dpt.installed	
Shooting Magnification	Inf~0.72x		0.053~1.1x	
W.D (mm)	Inf~M.O.D=185		WD=330~115	
Iris Range(F-stop)	F2.5~Close			
Object side N.A.	-		-	
Image side N.A.	-		-	
TV Distortion(%)	-0.3		-0.1	
Angle of View(Degrees)	inf wide	27.3x20.5°	WD=330 wide	165.4x123.8
	inf tele	4.7x3.5°	WD=330 tele	28.3x21.3
2/3 inch	WD=185 wide	67.0x50.1	WD=115 wide	43.8x32.8
	WD=185 tele	11.7x9.0	WD=115 tele	7.6x5.9
	inf wide	19.9x14.9°	WD=330 wide	120.0x89.8
	inf tele	3.4x2.6°	WD=330 tele	20.7x15.6
1/2 inch	WD=185 wide	48.6x36.5	WD=115 wide	31.8x23.8
	WD=185 tele	8.7x6.6	WD=115 tele	5.7x4.3
	inf wide	14.9x11.2°	WD=330 wide	89.8x67.4
	inf tele	2.6x2.0°	WD=330 tele	15.6x11.7
1/3 inch	WD=185 wide	36.5x27.3	WD=115 wide	23.8x17.9
	WD=185 tele	6.6x5.0	WD=115 tele	4.3x3.3
Mount	C-mount			
Control	Manual			
Focus	Manual			
Zoom	Manual			
Filter Thread(mm)	M52xP0.75			
Size(mm)(∞)	Φ62x171.7			
Weight(g)	595			
Temperature Range	-10°C~+50°C			

LMZ69M

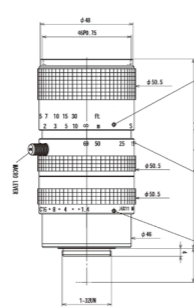

Model	LMZ69M
Focal Length(mm)	11.5~69(6x)
Image Size(mm)	8.8x6.6(Φ11)
Iris Range(F-stop)	F1.4~Close
Focusing Range(m)	1.0~∞
(Macro)	0.01
Control	Manual
Focus	Manual
Zoom	Manual
Angle of View(Degrees)	W41.9x32.0/T7.3x5.5
Mount	C-mount
Filter Thread(mm)	M46x0.75
Size(mm)(∞)	Φ50.5x98.2
Weight(g)	300
Temperature Range	-10°C~+50°C

† Images may differ from the actual product.

SC Series

Model	LM12SC	LM16SC	LM25SC	LM35SC	LM50SC
Focal Length(mm)	12	16	25	35	50
Image Size(mm)	12.8x9.6(Φ16)	12.8x9.6(Φ16)	12.8x9.6(Φ16)	12.8x9.6(Φ16)	12.8x9.6(Φ16)
Iris Range(F-stop)	F1.8~F16	F1.8~F16	F1.8~F16	F2.0~F16	F2.0~F16
Focusing Range(m)	0.1~∞	0.1~∞	0.15~∞	0.2~∞	0.3~∞
Control	Manual	Manual	Manual	Manual	Manual
Focus	Manual	Manual	Manual	Manual	Manual
Shooting Range at M.O.D.(mm)	125.5(H)x93.5(V)	93.5(H)x69.9(V)	86.1(H)x64.4(V)	69.9(H)x52.4(V)	70.1(H)x52.7(V)
Angle of View	1 Inch 55.9x43.1	44.0x33.6	28.9x21.8	20.8x15.6	14.6x11.0
View	2/3 Inch 39.8x30.2	30.9x23.3	20.1x15.2	14.3x10.8	10.1x7.6
(Degrees)	1/1.8 Inch 32.9x24.9	25.5x19.2	16.5x12.4	11.7x8.8	8.3x6.2
Resolution(Center, Corner)	160lp/mm,120lp/mm	160lp/mm,120lp/mm	160lp/mm,120lp/mm	160lp/mm,120lp/mm	160lp/mm,120lp/mm
TV Distortion(%)	-0.55	0.02	-0.34	0.02	0.30
Back Focus in Air(mm)	13.0	13.0	24.3	15.2	21.6
Mount	C-mount	C-mount	C-mount	C-mount	C-mount
Filter Thread(mm)	M40.5xP0.5	M34xP0.5	M34xP0.5	M34xP0.5	M34xP0.5
Size(mm)(∞)	Φ43x84.0	Φ43x80.0	Φ43x89.0	Φ43x74.0	Φ43x78.5
Weight(g)	255	240	245	200	210
Temperature Range	-10°C~+50°C	-10°C~+50°C	-10°C~+50°C	-10°C~+50°C	-10°C~+50°C

JC3M2 Series

Model	LM8JC3M2	LM12JC3M2	LM16JC3M2	LM25JC3M2	LM35JC3M2	LM50JC3M2
Focal Length(mm)	8	12	16	25	35	50
Image Size(mm)	8.8x6.6(Φ11)	8.8x6.6(Φ11)	8.8x6.6(Φ11)	8.8x6.6(Φ11)	8.8x6.6(Φ11)	8.8x6.6(Φ11)
Iris Range(F-stop)	F1.4~Close	F1.4~Close	F1.4~F16	F1.4~F16	F2.0~F16	F2.8~F22
Focusing Range(m)	0.1~∞	0.15~∞	0.2~∞	0.2~∞	0.2~∞	0.2~∞
Control	Manual	Manual	Manual	Manual	Manual	Manual
Focus	Manual	Manual	Manual	Manual	Manual	Manual
Shooting Range at M.O.D.(mm)	120.3(H)x90.0(V)	110.0(H)x82.5(V)	112.8(H)x84.4(V)	71.1(H)x53.3(V)	47.9(H)x35.8(V)	29.3(H)x21.9(V)
Angle of View	2/3 Inch 56.5x43.9	38.3x29.1	30.0x22.7	19.6x14.8	14.4x10.8	9.6x7.2
View	1/1.8 Inch 47.4x36.3	31.7x24.0	24.7x18.6	16.1x12.1	11.8x8.8	7.9x5.9
(Degrees)	1/2 Inch 42.6x32.5	28.3x21.4	21.8x16.4	14.0x10.5	10.5x7.9	7.0x5.2
Resolution(Center, Corner)	120lp/mm,100lp/mm	120lp/mm,100lp/mm	120lp/mm,100lp/mm	120lp/mm,100lp/mm	120lp/mm,100lp/mm	120lp/mm,100lp/mm
TV Distortion(%)	-0.6	-0.07	-0.05	-0.04	-0.2	-0.03
Back Focus in Air(mm)	9.74	11.7	13.1	11.7	20.1	35.5
Mount	C-mount	C-mount	C-mount	C-mount	C-mount	C-mount
Filter Thread(mm)	M27xP0.5	M27xP0.5	M27xP0.5	M27xP0.5	M27xP0.5	M27xP0.5
Size(mm)(∞)	Φ34x41.6	Φ34x37	Φ33.5x36.5	Φ33.5x39.5	Φ34x36.5	Φ34x55
Weight(g)	90	85	85	90	70	95
Temperature Range	-10°C~+50°C	-10°C~+50°C	-10°C~+50°C	-10°C~+50°C	-10°C~+50°C	-10°C~+50°C

HC-IR Series

Model	LM50HC-IR	LM60HC-IR
Focal Length(mm)	50	60
Image Size(mm)	12.8x9.6(Φ16)	12.8x9.6(Φ16)
Iris Range(F-stop)	F1.8~F16	F2.0~F16
Focusing Range(m)	1.0~∞	1.0~∞
Control	Manual	Manual
Focus	Manual	Manual
Shooting Range at M.O.D.(mm)	246.0(H)x184.0(V)	216.9(H)x162.1(V)
Angle of View	1 Inch 14.4x10.8	12.2x9.2
View	2/3 Inch 9.9x7.5	8.4x6.3
(Degrees)	1/1.8 Inch 8.2x6.2	6.9x5.2
Resolution(Center, Corner)	160lp/mm, 125lp/mm	160lp/mm, 125lp/mm
TV Distortion(%)	-0.09	-0.06
Back Focus in Air(mm)	20.4	15.7
Mount	C-mount	C-mount
Filter Thread(mm)	-	M37.5xP0.5
Size(mm)(∞)	Φ50.0x47.4	Φ49.2x54.6
Weight(g)	180	200
Temperature Range	-10°C~+50°C	-10°C~+50°C

LMVZ166HC

Model	LMVZ166HC
Focal Length(mm)	16~64(4.0x)
Image Size(mm)	12.8x9.6(Φ16)
Iris Range(F-stop)	F1.8~F16
Focusing Range(m)	1.0~∞
Control	Manual
Focus	Manual
Shooting Range at M.O.D.(mm)	W881.4x639.7/T238.2x177.9
Angle of View	1 Inch W45.9x34.2/T11.7x14.6
View	2/3 Inch W31.3x23.4/T8.1x6.1
(Degrees)	1/1.8 Inch W25.5x19.1/T6.6x5.0
TV Distortion(%)	W-3.4/T0.2
Back Focus in Air(mm)	W29.2/T29.5
Mount	C-mount
Filter Thread(mm)	M58xP0.75
Size(mm)(∞)	Φ60x124
Weight(g)	370
Temperature Range	-10°C~+50°C

† Images may differ from the actual product.

JC5MCseries

LM8JC5MC

Table with columns: WD, Magnification, Fields of View (mm) for 2/3", 1/1.8", and 1/2". Rows include magnification values from 0.008 to 0.051.

LM16JC5MC

Table with columns: WD, Magnification, Fields of View (mm) for 2/3", 1/1.8", and 1/2". Rows include magnification values from 0.016 to 0.080.

NCM/JC1MSseries

JC3NCM

Table with columns: WD, Magnification, Fields of View (mm) for 1/1.8", 1/2", and 1/3". Rows include magnification values from 0.00360 to 0.03210.

LM6NCM

Table with columns: WD, Magnification, Fields of View (mm) for 1/1.8", 1/2", and 1/3". Rows include magnification values from 0.00600 to 0.05380.

LM12JC5MC

Table with columns: WD, Magnification, Fields of View (mm) for 2/3", 1/1.8", and 1/2". Rows include magnification values from 0.012 to 0.057.

LM25JC5MC

Table with columns: WD, Magnification, Fields of View (mm) for 2/3", 1/1.8", and 1/2". Rows include magnification values from 0.025 to 0.120.

LM4NCM

Table with columns: WD, Magnification, Fields of View (mm) for 1/1.8", 1/2", and 1/3". Rows include magnification values from 0.00450 to 0.03900.

LM5JCM

Table with columns: WD, Magnification, Fields of View (mm) for 2/3", 1/1.8", and 1/2". Rows include magnification values from 0.00490 to 0.04440.

LM8JC1MS

Table with columns: WD, Magnification, Fields of View (mm) for 2/3", 1/1.8", and 1/2". Rows include magnification values from 0.00820 to 0.07450.

LM16JC1MS

Table with columns: WD, Magnification, Fields of View (mm) for 2/3", 1/1.8", and 1/2". Rows include magnification values from 0.01640 to 0.07870.

LM35JC1MS

Table with columns: WD, Magnification, Fields of View (mm) for 2/3", 1/1.8", and 1/2". Rows include magnification values from 0.03540 to 0.18350.

LM75JC1MS

Table with columns: WD, Magnification, Fields of View (mm) for 2/3", 1/1.8", and 1/2". Rows include magnification values from 0.03880 to 0.06620.

LM12JC1MS

Table with columns: WD, Magnification, Fields of View (mm) for 2/3", 1/1.8", and 1/2". Rows include magnification values from 0.01260 to 0.07960.

LM25JC1MS

Table with columns: WD, Magnification, Fields of View (mm) for 2/3", 1/1.8", and 1/2". Rows include magnification values from 0.02540 to 0.12460.

LM50JC1MS

Table with columns: WD, Magnification, Fields of View (mm) for 2/3", 1/1.8", and 1/2". Rows include magnification values from 0.05360 to 0.30100.

LM100JC1MS

Table with columns: WD, Magnification, Fields of View (mm) for 2/3", 1/1.8", and 1/2". Rows include magnification values from 0.03430 to 0.05220.

Various types of lenses are used in machine vision systems. In order to achieve the highest performance, it is important to select the lens most suitable for the application.

Product Number Breakdown Ex. **LM 12 JCM**

- ① Represents lens function
- ② Represents focal length (fixed focal length lenses)
- ③ Represents format sizes and lens type

- LM.....KOWA CCTV lenses
- LMZ.....KOWA Zoom lenses
- LMVZ.....KOWA Varifocal lenses
- XC.....4/3 inch format megapixel lens
- CLS.....3CCD color line scan lens
- SC,HC.....1 inch format megapixel lens
- HC-SW.....1 inch format SWIR lens
- JC.....2/3 inch format lens
- JCM.....2/3 inch format megapixel lens
- NCL.....1/2 inch format lens
- NCM.....1/2 inch format megapixel lens
- M.....Macro lens
- TC.....Telecentric lens
- NC3.....1/2 inch format 3CCD megapixel lens
- IR.....IR-corrected lens
- NF.....NF mount lens

Quick selection - How to calculate focal length

Ex) A 2/3" camera is used to capture an object 100mm wide from a distance of 300mm. Use the picture below and the image size chart to substitute for Y, L, and Y'. Then, to capture the entire object, use the formula $f=L*Y'/Y$ to calculate focal length.

$Y=8.8\text{mm}$ (See image size chart), $L=300\text{mm}$, $Y=100\text{mm}$
 $f=300*8.8/100$
 $f=26.4\text{mm}$

The most appropriate lens is f=25mm lens, which is close but not greater than the 26.4 derived from the calculation. Lenses with shorter focal lengths than the given number can capture an object in its entirety.

Quick selection - How to calculate the angle of view

Ex) A 1/2" camera is used to shoot an object 300mm away. The focal length of the lens is 16mm. Use the picture below and image size chart to substitute for f, L, and Y1 (H or V accordingly). Then to calculate the angle of view, use the formula $Y=L*Y'/f$.

Width- $Y=6.4\text{mm}$ (Horizontal), $f=16\text{mm}$, $L=300\text{mm}$
 $Y=300*6.4/16$
 $Y=120\text{mm}$
 Vertical- $Y=4.8\text{mm}$ (Vertical), $f=16\text{mm}$, $L=300\text{mm}$
 $Y=300*4.8/16$
 $Y=90\text{mm}$

Thus in order to capture the object in its entirety, the maximum dimensions of an object at a distance of 300mm is 120mm wide and 90mm height.

<Characteristics of lenses are described below>

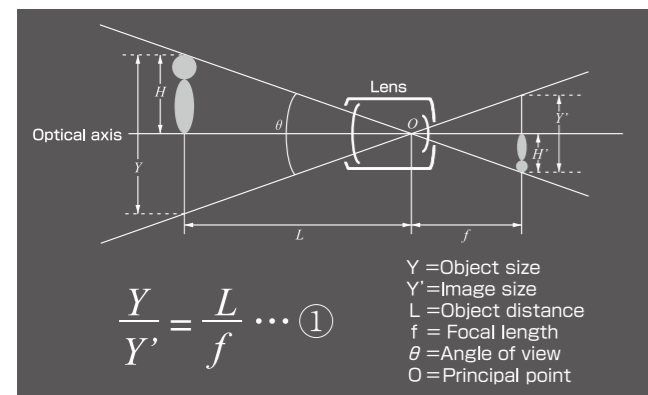

- Object size..... Field range which can be captured by the image sensor
- Image size..... See description
- Object distance Distance from the lens to the object
- Focal length..... Distance from the principal point to the focus point
- Angle of view..... This angle represents a shooting range in degrees. The shorter a focal length is, the bigger an angle of view is.
- Principal point..... Optical center of the lens

Image size

Image size represents size of camera sensor

Camera	Hor.(mm)	Ver.(mm)	Dia.(mm)
1/4inch	3.6	2.7	4.5
1/3inch	4.8	3.6	6
1/2inch	6.4	4.8	8
1/1.8inch	7.2	5.4	9
2/3inch	8.8	6.6	11
1inch	12.8	9.6	16
1.1inch	14.1	10.6	17.6
1.2inch	15.4	11.5	19.2
4/3inch	18.4	13.8	23
APS-C	22.3	16.7	27.9
2@32)inch	25.6	19.2	32

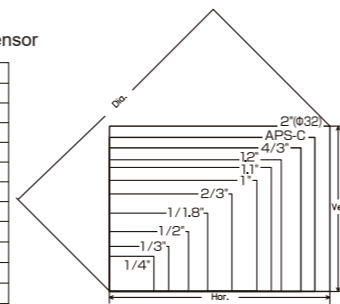

F-number

The F-number represents the amount of light that passes through a lens. As the F-number decreases, the amount of light that passes through the lens increases. The F-number affects the depth of field as mentioned below.

Depth of field

Depth of field is the range of distance, in front of and behind a subject that appears in focus. If the depth of field is deep, an object will appear to be in focus even if it moves slightly back and forth.

The characteristics of depth of field (comparing lenses with the same specifications)

- Increasing the F-number (darker) increases the depth.
- Shortening the focal length increases the depth.
- Lengthening the object distance increases the depth.

Floating Mechanism system

The floating mechanism system is effective in preventing malfunction and increasing the life of the lens. It is also called the close distance aberration compensation mechanism.

In standard CCTV lenses, the whole or a part of the lens moves when focusing. However, moving one lens element and not the entire lens system changes the direction of the light rays and decreases the optical performance.

However, lenses with the floating mechanism system can vary the distance between the lens elements. This enables the lens to achieve the highest performance at various objective distances.

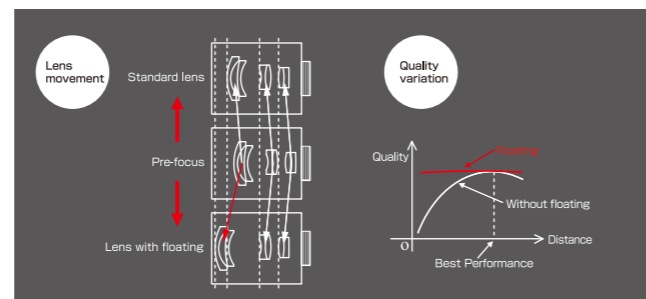

Lens processing facility

Kowa has the facility to manufacture any optical device with the requested specifications.

Examples of optical devices

- Parabolic mirrors
- Plastic molded lenses
- Germanium lenses
- Special filters
- Aspherical Lenses

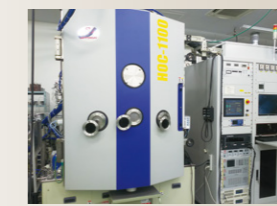

Coating machine



Spectrophotometer

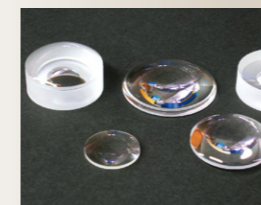

Spherical and Aspherical lenses

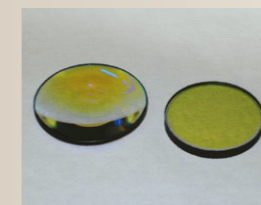

YAG laser cut optical devices

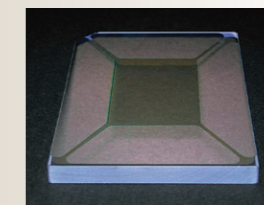

Special mirrors

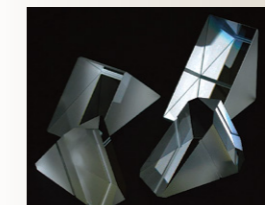

Various prisms

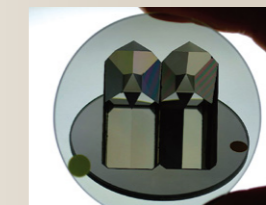

Optical devices with special coatings



Ultra-precision optical devices

Design & Development

OEM Product Design

Kowa has the ability to create an OEM customized optical system, which includes the optical, mechanical, electrical and software design. We will provide you the best solution for every customer who requires high-end customized products.

Example of Customized Optics

- Optics for Medical X-ray diagnostics
- Optics for Semiconductor instruments
- Optics for laser scanning applications
- Optics for surveillance applications
- Optics for printing applications

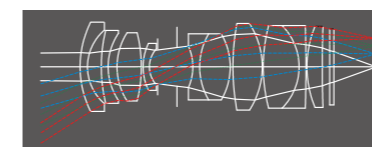

Kowa will provide suggestions about the customized optics based on the flow chart below.

